



CATALOG 2015

VENTILATION and THERMOS

cata 



CATALOG 2015

VENTILATION and THERMOS

CATA WORLDWIDE

In over 80 countries

Manufacturer of extractor fans, Cata was founded in Torelló in 1947. Since then, it has been a pioneer in extraction.

Its extensive product catalogue includes the most complete and innovative range of Domestic and Professional Extraction.



Based in Torelló, in the province of Barcelona, Cata also owns factories in Sao Paulo (Brazil) and Xiao Lan (China) and is in constant international expansion thanks to its team of professionals committed to the manufacture and marketing of an extensive range of products.

Cata has reached its position as leader in the extraction market thanks to its great capacity to innovate and its ability to anticipate market needs. Over recent years, it has undergone significant growth in both the Spanish and international markets, based on excellent quality and a high degree of competitiveness in all its products.

Cata's commitment to quality has been borne out by the highest certification, ISO 9001, awarded by the Bureau Veritas Quality International and accredited by the Dutch Council for Accreditation. These international standards ensure a maximum level of quality in the design and manufacture of all products. Likewise, Cata products respond to technical and safety regulations and have been obtained the European approvals of the C. C. A. (Cenelec Certificate Agreement). As a result, Cata is currently one of the leading extraction companies in the world.

COMPREHENSIVE VENTILATION SOLUTIONS

WHAT WE OFFER

Integral ventilation solutions. Reliability, Quality, Innovation and Design. Proven experience in ventilation. International industrial capacity. Global service. And most importantly to our customers: **BENEFITS AND ADVANTAGES**

COMPREHENSIVE VENTILATION SOLUTIONS:

CATA provides subscribers, wholesalers and professionals from the sector an extensive product range, which will allow them to choose the most suitable model for every ventilation case or need, at both domestic and industrial level, and now also **models and ranges to comply with the Technical Building Code (CTE), in accordance with Royal Decree 314/2006, dated 17th March 2006.**

RELIABILITY, QUALITY, INNOVATION AND DESIGN

These concepts are basic and mandatory for **CATA** and are the main basis for all our products. For this reason, a qualified team of engineers assisted by the most modern design systems work to ensure the highest levels of quality and innovation to offer highly reliable ventilation products manufactured according to the **ISO 9001/2000 standard Management System.**

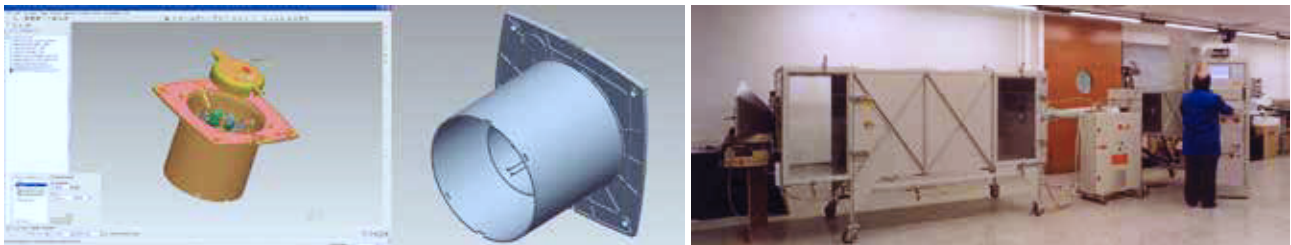

PROVEN EXPERIENCE IN VENTILATION

A pioneer in the manufacturing of fans, **CATA** has over 60 years' experience in ventilation, strengthening its position as a world leader thanks to the export of proprietary technology and differentiated products.

INTERNATIONAL INDUSTRIAL CAPACITY

CATA has a very important industrial asset, with several production centres around the world equipped with the most modern technology and machinery to be able to offer efficient and competitive distribution of our products and components.

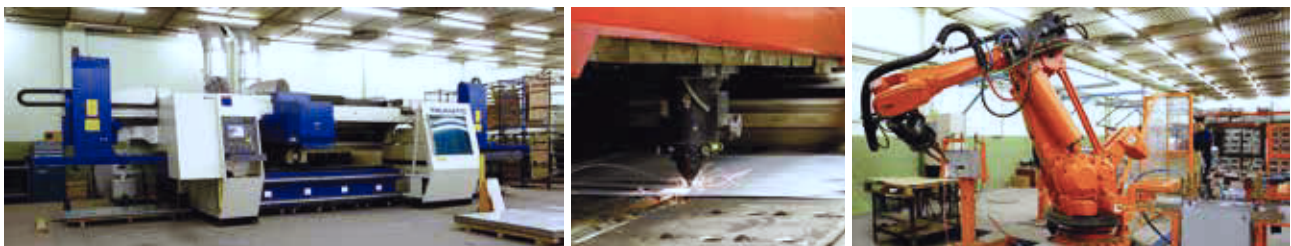

GLOBAL SERVICE

CATA has a multicultural team with a high level of training and a clear customer care and service orientation. In addition, to offer a better service, we have logistics and distribution centres and subsidiaries around the world.

AND MOST IMPORTANTLY TO OUR CUSTOMERS: BENEFITS AND ADVANTAGES

These are the main aims that the **CATA Ventilation Division** wishes to offer the distributors, customers and professionals in the sector. For this reason, we work and renew our efforts daily to ensure that these objectives are possible.

AXIAL BATHROOM FANS

E GLASS SERIES. Energy-efficient. Low-noise

E - p.8-9

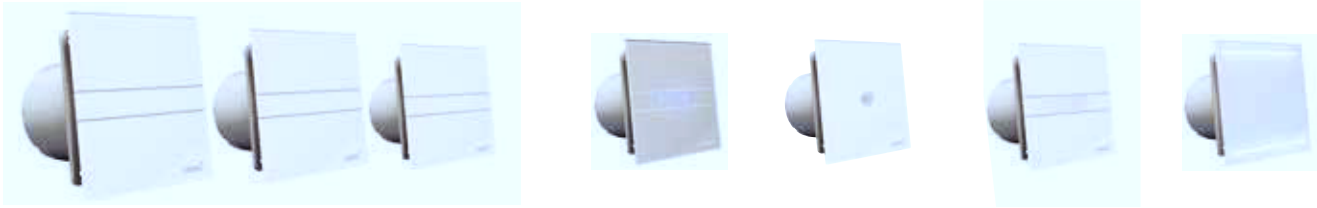

MATIC SERIES

X-MART Matic - p. 10

B-Matic - p. 11



DESIGN SERIES

X-MART - p. 12

SILENTIS - p. 13

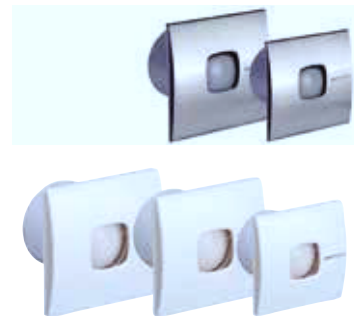

CLASIC SERIES

B-Plus - p. 14

B - p. 15

B-Pir - p. 15



CENTRIFUGAL BATHROOM FANS

CB 100 PLUS - p. 16

CB-250 PLUS - p. 16



IN-LINE DUCT FANS

Professional Series

Duct in line - p. 17



Box in line - p. 18



Axial

MT - p. 19

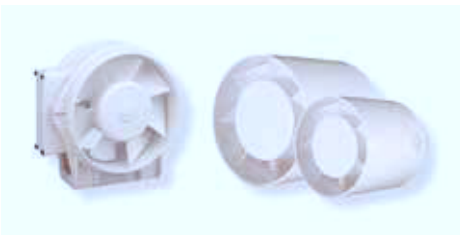

Kit in Line - p. 19



WALL FANS

LHV - p. 20

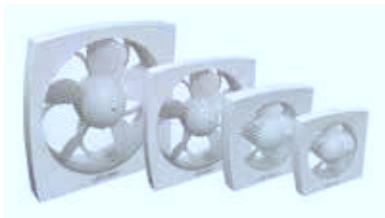

B - p. 21



KITCHEN EXTRACTION

Professional 750 / 500- p. 22



600 PLUS 2V / GS 600 - p. 23



GS 400M / GS 400 P - p. 23



DOMESTIC VENTILATION ACCESSORIES

Accessories - p. 24-25



Fixed Grill



Grill on pressure

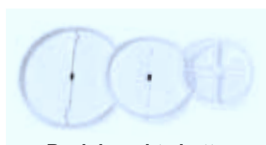

Backdraught shutter



MT support

PERFORMANCE CURVES

p. 27 - 31

AXIAL BATHROOM FANS

E GLASS Series. Energy-efficient. Low-noise



AMBIENT LIGHT



VERY SILENT



HIGHT ENERGY EFFICIENCY



LED 2x2W
ADJUSTABLE INTENSITY



LIGHTED DISPLAY



FRONT GLASS



PIR: INFRA RED SENSOR
ACTIVATED BY PRESENCE

- **Perimeter extraction** system.
- **Glass cover.**
- Available models with ambient light and infra-red sensor activated by presence (ø100).
- **High-performance plastic housing and impeller.**
- **Temperature and humidity display** (available on humidistat model).
- Backdraught shutter (accessory).
- Fitted with 220-240 50/60Hz motors (110-127V 60Hz on request), IP-44 protection and insulation class B as standard.
- **Minimum sound level of 17dB (according to the model)**
- 2-speed function (humidistat version only), to be selected prior to installation between continuous or NON continuous working.
 - 1st speed: slow speed for continuous extraction.
 - 2nd speed: activates when light is switched on, by activating the humidistat or the timer.



E-100 GLASS PIR - Infra red sensor, activated by presence

E-100 GLASS LIGHT

REMOVABLE GLASS FRONT



EASILY REMOVABLE

Easy and speedy removal of the cover using a single tool (included in the packaging) which is also used to adjust the timer (GT and GTH version) and the humidistat (GTH version).

EASY TO CLEAN

Extra-flat glass cover that is easy to clean just by running a damp cloth over it.

E-100 G
E-120 G
E-150 G
E-100 GT

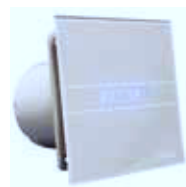

E-100 GST
E-100 GSTH



E-100 PIR



E-100 GTH

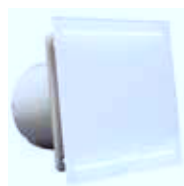

E-100 GL

CODE	MODEL	EAN CODE	VERSION	Ø (mm)	Speed (r.p.m)	Input Power (W)	Maximum Airflow (m³/h)	Sound Pressure Level dB(A)	Units per box
HYGRO SERIES									
00900200 GLASS TIMER HYGRO	E-100 GTH	8422248049634		100	1ª vel 1100	4 2ª vel 2600	36 8	17 115	6 31
00901200 GLASS TIMER HYGRO	E-120 GTH	8422248056823		120	1ª vel 900	6 2ª vel 2400	140 11	19 210	6 33
00902200 GLASS TIMER HYGRO	E-150 GTH	8422248056854		150	1ª vel 900	10 2ª vel 2400	225 19	23 350	6 35
00900600 GLASS SILVER TIMER HYGRO	E-100 GSTH	8422248056076		100	1ª vel 1100	4 2ª vel 2600	36 8	17 115	6 31
TIMER SERIES									
00900100 GLASS TIMER	E-100 GT	8422248049627		100	2600	8	115	31	6
00901100 GLASS TIMER	E-120 GT	8422248056816		120	2400	15	210	33	6
00902100 GLASS TIMER	E-150 GT	8422248056847		150	2200	21	350	35	6
00900500 GLASS SILVER TIMER	E-100 GST	8422248056069		100	2600	8	115	31	6
STANDAR SERIES									
00900000 GLASS	E-100 G	8422248049610		100	2600	8	115	31	6
00900400 GLASS SILVER	E-100 GS	8422248056052		100	2600	8	115	31	6
00900001 GLASS LIGHT	E-100 GL	8422248056786		100	2600	8+4	115	31	6
00901000 GLASS	E-120 G	8422248056809		120	2400	15	210	33	6
00902000 GLASS	E-150 G	8422248056830		150	2200	21	350	35	6
PIR SERIES									
00900300 PRESENCE DETECTOR	E-100 PIR	8422248057622		100	2600	8	115	31	6

DIMENSIONS mm

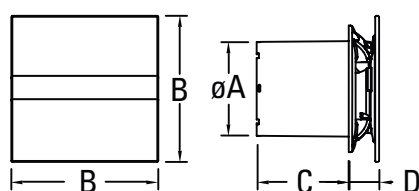

	Ø A	B	C	D
E GLASS -100	98	150	94	28,5
E GLASS -120	118	170	94	35
E GLASS -150	148	190	94	45
E GLASS -100 LIGHT	98	150	94	35

Versions



STANDARD
In combination with light, fans switches on.



TIMER
Electronic timer adjustable from 3 to 15 minutes.



HYGRO
Adjustable humidity detector from 40% to 95%, and adjustable electronic timer from 0 seconds to 15 minutes.



PIR
Infra red sensor activated by presence and adjustable electronic timer from 40 seconds to 15 minutes.

Perimetral bathroom fans, with unique automatic shutter system.

X-MART MATIC / X-MART MATIC INOX



- **Automatic shutter** system.
- Recessed and **design** of a new generation.
- **QUICK FIX GRIP**, exclusive mounting system
- **Front cover easy to dismantle without using any tools**, easy cleaning.
- Plastic housing, impeller and led.
- 220-240V 50/60Hz motors, protection **IP-X4** insulation class **B** and thermal cut out, ambient temperature max. 40°C.
- Pilot light operation
- Finishes: White / Stainless Steel.



QUICK
FIX GRIP



AUTOMATIC
SHUTTER
SYSTEM

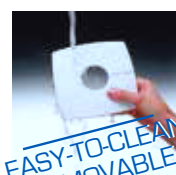

EASY-TO-CLEAN
REMOVABLE
COVER

CODE	MODEL	EAN CODE	VERSION	Ø (mm)	Speed (r.p.m)	Input Power (W)	Maximum AirFlow (m³/h)	Sound Pressure Level dB(A)	Weight (kg)	Units per box
------	-------	----------	---------	--------	---------------	-----------------	------------------------	----------------------------	-------------	---------------

TIMER SERIES

01016000	X-MART 10 MATIC T	8422248003551	●	100	2500	15	98	38	0,65	10
01026000	X-MART 12 MATIC T	8422248003582	●	120	2450	20	190	40	0,82	5
01046000	X-MART 10 MATIC INOX T	8422248003735	●	100	2500	15	98	38	0,78	10
01056000	X-MART 12 MATIC INOX T	8422248003766	●	120	2450	20	190	40	0,98	5
01066000	X-MART 15 MATIC INOX T	8422248003797	●	150	2100	25	320	42	1,14	5

STANDAR SERIES

01015000	X-MART 10 MATIC	8422248003544	●	100	2500	15	98	38	0,65	10
01025000	X-MART 12 MATIC	8422248003575	●	120	2450	20	190	40	0,82	5
01035000	X-MART 15 MATIC	8422248003605	●	150	2100	25	320	42	0,97	5
01045000	X-MART 10 MATIC INOX	8422248003728	●	100	2500	15	98	38	0,78	10
01055000	X-MART 12 MATIC INOX	8422248003759	●	120	2450	20	190	40	0,98	5
01065000	X-MART 15 MATIC INOX	8422248003780	●	150	2100	25	320	42	1,14	5

DIMENSIONS mm

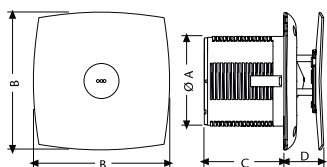

	Ø A	B	C	D
X-MART MATIC 10	98	150	87	38 máx.
X-MART MATIC 12	118	170	101	38 máx.
X-MART MATIC 15	148	194	120	38 máx.

Versions



STANDARD

In combination with light, fans switches on.



TIMER

Electronic timer adjustable from 3 to 15 minutes.

Axial fans for bathrooms, with short tube, to be installed in ceiling, wall or window.

B-MATIC



- With **automatic shutter**.
- White finish.
- Plastic housing and impeller.
- 220-240V 50/60Hz motors, protection **IP-X4**, insulation class **B** and thermal cut out, ambient temperature max. 40°C.

CODE	MODEL	EAN CODE	VERSION	Ø (mm)	Speed (r.p.m)	Input Power (W)	Maximum AirFlow (m³/h)	Sound Pressure Level dB(A)	Weight (kg)	Units per box
SERIE TIMER										
00916000	B-10 MATIC T	8422248110303	●	100	2500	15	98	41	0,70	5
00926000	B-12 MATIC T	8422248110808	●	120	2450	20	190	43	0,90	5
SERIE ESTANDAR										
00915000	B-10 MATIC	8422248110204	●	100	2500	15	98	41	0,70	5
00925000	B-12 MATIC	8422248110709	●	120	2450	20	190	43	0,90	5
00935000	B-15 MATIC	8422248111102	●	150	2100	28	320	43	1,20	5

DIMENSIONS mm

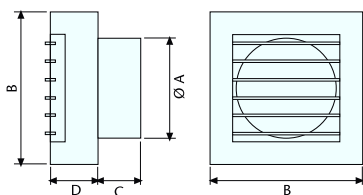

	Ø A	B	C	D
B-10 MATIC	98	150	42	47
B-12 MATIC	118	180	45	56
B-15 MATIC	148	209	60	58

Versions



STANDARD
In combination with light, fans switches on.



TIMER
Electronic timer adjustable from 3 to 15 minutes.

Perimetral bathroom fans.

X-MART / X-MART INOX

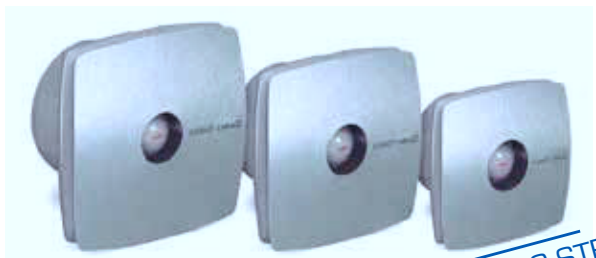

STAINLESS STEEL
VERSION



- Aerodynamic and cutting-edge **design**.
- **QUICK FIX GRIP**, exclusive mounting system.
- **Backdraught shutters incorporated**.
- **Front cover easy to dismantle without using any tools**, easy cleaning.
- 220-240V 50/60Hz motors, protection **IP-X4** insulation class **B** and thermal cut out, ambient temperature max. 40°C.
- Plastic housing, impeller and led.
- Pilot light operation
- Finishes: White / Stainless Steel.

CODE	MODEL	EAN CODE	VERSION	Ø (mm)	Speed (r.p.m)	Input Power (W)	Maximum AirFlow (m³/h)	Sound Pressure Level dB(A)	Weight (kg)	Units per box
HYGRO SERIES										
01044000	X-MART 10 INOX H	8422248003650	●	100	2500	15	98	38	0,66	5
01054000	X-MART 12 INOX H	8422248003681	●	120	2450	20	190	40	0,87	5
01064000	X-MART 15 INOX H	8422248003711	●	150	2100	25	320	42	1,04	5
TIMER SERIES										
01011000	X-MART 10 T	8422248003414	●	100	2500	15	98	38	0,64	10
01021000	X-MART 12 T	8422248003438	●	120	2450	20	190	40	0,84	5
01041000	X-MART 10 INOX T	8422248003643	●	100	2500	15	98	38	0,66	10
01051000	X-MART 12 INOX T	8422248003674	●	120	2450	20	190	40	0,87	5
01061000	X-MART 15 INOX T	8422248003704	●	150	2100	25	320	42	1,04	5
STANDAR SERIES										
01010000	X-MART 10	8422248003384	●	100	2500	15	98	38	0,64	10
01020000	X-MART 12	8422248003391	●	120	2450	20	190	40	0,84	5
01030000	X-MART 15	8422248003407	●	150	2100	25	320	42	1,02	5
01040000	X-MART 10 INOX	8422248003636	●	100	2500	15	98	38	0,66	10
01050000	X-MART 12 INOX	8422248003667	●	120	2450	20	190	40	0,87	5
01060000	X-MART 15 INOX	8422248003698	●	150	2100	25	320	42	1,04	5

DIMENSIONS mm

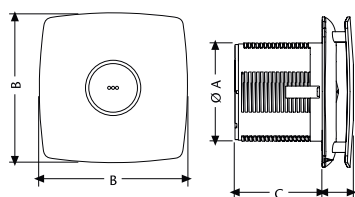

	Ø A	B	C	D
X-MART 10	98	150	89,5	31
X-MART 12	118	170	103,5	32
X-MART 15	148	194	123,5	34

Versions



STANDARD
In combination with light, fans switches on.



TIMER
Electronic timer adjustable from 3 to 15 minutes.



HYGRO
Adjustable humidity detector from 40% to 90%, and adjustable electronic timer from 0 to 15 minutes.

Completely built-in bathroom fans with perimetral and central extraction system, high-performance and low noise level.

SILENTIS / SILENTIS INOX

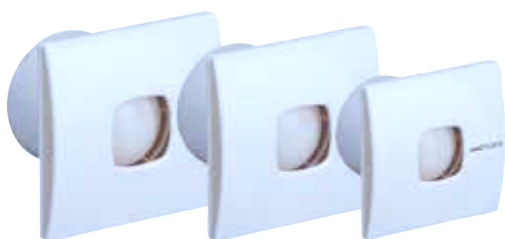

- Cutting-edge **design**.
- **Backdraught shutters incorporated**.
- Front cover easy to dismantle and to clean.
- Plastic housing and impeller and led.
- 220-240V 50/60Hz motors, protection **IP-X4** insulation class **B** and thermal cut out, ambient temperature max. 40°C.
- Finishes: White / Stainless Steel.



CODE	MODEL	EAN CODE	VERSION	Ø (mm)	Speed (r.p.m)	Input Power (W)	Maximum AirFlow (m³/h)	Sound Pressure Level dB(A)	Weight (kg)	Units per box
SERIE TIMER										
01071000	SILENTIS 10 T	8422248016940	●	100	2500	15	98	37	0,64	10
01071300	SILENTIS 10 INOX T	8422248016964	●	100	2500	15	98	37	0,64	10
01081300	SILENTIS 12 INOX T	8422248017008	●	120	2450	20	190	39	0,85	5
STANDAR SERIES										
01070000	SILENTIS 10	8422248016643	●	100	2500	15	98	37	0,64	10
01080000	SILENTIS 12	8422248016971	●	120	2450	20	190	39	0,85	5
01090000	SILENTIS 15	8422248017015	●	150	2100	25	320	41	1,02	5
01070300	SILENTIS 10 INOX	8422248016957	●	100	2500	15	98	37	0,64	10
01080300	SILENTIS 12 INOX	8422248016995	●	120	2450	20	190	39	0,85	5

DIMENSIONS mm

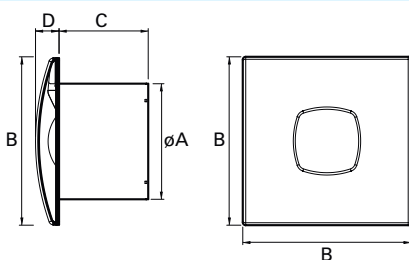

	Ø A	B	C	D
SILENTIS 10	98	140	80	22
SILENTIS 12	118	170	95	30
SILENTIS 15	148	190	112	32

Versions



STANDARD
In combination with light, fans switches on.



TIMER
Electronic timer adjustable from 3 to 15 minutes.

Axial fans for bathrooms, very slim, to be installed in ceiling or wall.

B-PLUS



- Very slim, recessed design.
- Plastic housing and impeller.
- 220-240V 50/60Hz motors, protection **IP-X4**, insulation class **B** and thermal cut out, ambient temperature max. 40°C.
- Light sensor in **HUMIDISTAT** version and **B15 PLUS** models.
- Window kit not available for models **B8 PLUS** and **B15 PLUS**.



CODE	MODEL	EAN CODE	VERSION	Ø (mm)	Speed (r.p.m)	Input Power (W)	Maximum AirFlow (m³/h)	Sound Pressure Level dB(A)	Weight (kg)	Units per box
SERIE HYGRO										
00981401	B10 PLUS H	8422248050876	●	100	2500	15	98	41	0,6	10
SERIE TIMER										
00981101	B10 PLUS T	8422248049566	●	100	2500	15	98	41	0,6	10
00982100	B12 PLUS T	8422248113489	●	120	2450	20	190	43	0,8	5
00983100	B15 PLUS T	8422248114257	●	150	2100	28	320	43	0,9	5
SERIE ESTANDAR										
00990000	B8 PLUS	8422248113168	●	90	2500	15	70	39	0,57	10
00281000	B10 PLUS	8422248047210	●	100	2500	15	98	41	0,6	10
00282000	B12 PLUS	8422248053969	●	120	2450	20	190	43	0,8	5
00283000	B15 PLUS	8422248047227	●	150	2100	28	320	43	0,9	5

DIMENSIONS mm

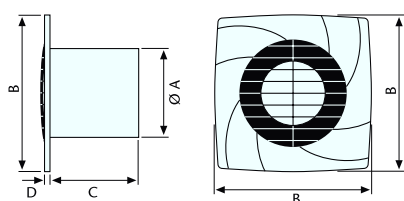

	Ø A	B	C	D
B-8 PLUS	86	140	88	10
B-10 PLUS	98	140	85	10
B-12 PLUS	118	170	100	13
B-15 PLUS	148	190	112	15

Versions



STANDARD
In combination with light, fans switches on.



TIMER
Electronic timer adjustable from 3 to 15 minutes.



HYGRO
Adjustable humidity detector from 40% to 90%, and adjustable electronic timer from 0 to 15 minutes.

Axial fans for bathrooms with short tube for wall, ceiling and glass (using Glass Kit accessory).

B



- White finishing.
- Plastic housing and impeller.
- Fitted with 220-240V 50/60Hz motors, **IP-X4** protection and class **B** as standard.
- Neon light sensor in humidistat versions.

SHORT TUBE

CODE	MODEL	EAN CODE	VERSION	Ø (mm)	Speed (r.p.m)	Input Power (W)	Maximum AirFlow (m³/h)	Sound Pressure Level dB(A)	Weight (kg)	Units per box
SERIE TIMER										
00911000	B-10 T	8422248110105	●	100	2500	15	98	41	0,60	10
SERIE ESTANDAR										
00910000	B-10	8422248110006	●	100	2500	15	98	41	0,60	10
00920000	B-12	8422248110501	●	120	2450	20	190	43	0,85	5
00930000	B-15	8422248110907	●	150	2100	28	320	43	0,95	5

DIMENSIONS mm

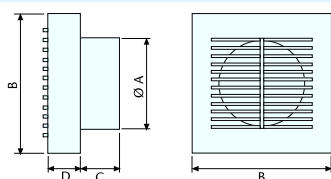

	Ø A	B	C	D
B-10	98	150	42	35
B-12	118	180	45	44
B-15	148	209	60	45

Axial fans for bathrooms with infra-red sensor.

B-PIR



- Fitted with infra-red sensor activated by presence.
- Timer (electronic timer adjustable from 3 to 15 minutes).
- White finishing.
- Plastic housing and impeller.
- 220-240V 50/60Hz motor, protection **IP-X4**, insulation class **B** as thermal cut out, ambient temperature max. 40°C.

SHORT TUBE

CODE	MODEL	EAN CODE	Ø (mm)	Speed (r.p.m)	Input Power (W)	Maximum AirFlow (m³/h)	Sound Pressure Level dB(A)	Weight (kg)	Units per box
00913000	B-10 PIR	8422248112123	100	2500	15	98	41	0,60	4

DIMENSIONS mm

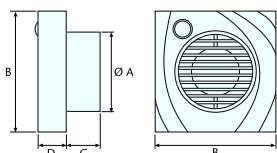

	Ø A	B	C	D
B-10 PIR	98	150	42	35

Versions



STANDARD
In combination with light, fans switches on.



TIMER
Electronic timer adjustable from 3 to 15 minutes.



PIR
Infra red sensor activated by presence and adjustable electronic timer from 40 seconds to 15 minutes.

CENTRIFUGAL BATHROOM FANS

High-performance centrifugal bathroom fans, slim version, to be installed in ceilings or walls.

CB-100 PLUS / CB-250 PLUS



CB-100 PLUS



CB-250 PLUS

- **CB-100 PLUS** totally recessed.
- Finishing: white.
- **CB-250** with short tube.
- Modern slim version.
- Centrifugal impeller for high pressure, which need to be passed in longer ductings.
- **Backdraught shutters included.**
- Plastic housing and impeller.
- 220-240V 50/60Hz motors, protection **IP-X4**, insulation class **B** and thermal cut out, ambient temperature max. 40°C.



CODE	MODEL	EAN CODE	VERSION	Ø (mm)	Speed (r.p.m)	Input Power (W)	Maximum AirFlow (m³/h)	Sound Pressure Level dB(A)	Weight (kg)	Units per box
TIMER SERIES										
00841000	CB-100 PLUS T	8422248114394	●	100	2300	25	130	49	0,98	5
STANDARD SERIES										
00840000	CB-100 PLUS	8422248114387	●	100	2300	25	130	49	0,98	5
00850000	CB-250 PLUS	8422248114417	●	100/120	2300	45	270	52	1,64	5

DIMENSIONS mm

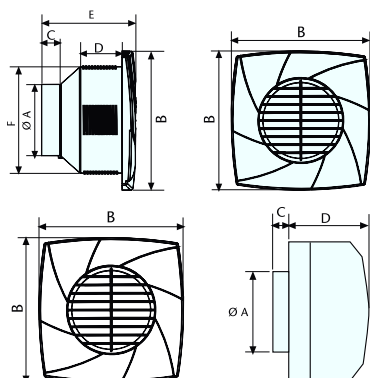

	Ø A	B	C	D	E	F
CB-100 PLUS	97,6	190	26	57,4	129,4	147,8

	Ø A	B	C	D
CB-250 PLUS	96/118	208	17	122

* Double outflow diameter included.

Versions



STANDARD
In combination with light, fans switches on.



TIMER
Electronic timer adjustable from 3 to 15 minutes.

IN-LINE DUCT FANS

In-line mixed flow fans with high performance air flow capacity and low noise level.

DUCT IN-LINE



Fan:

- Housing polypropylene plastic.
- Easy accessible motor due to the motor support, which can be dismantled without interfering existing duct system. (1)

Motor:

- Asynchronous 1, 2 and 3 speeds motor, self-lubricating bearings for life.
- Protection **IP44** insulation Class **B** (not **DUCT IN-LINE 100/130**), and thermal cut out.
- External terminal box.
- 230 V at 50 and 60 Hz (**DUCT IN-LINE 100/130**, just in 50 Hz).
- Speed control possible (not timer versions).
- **TIMER** version models adjustable from 3 to 15 minutes.

Impeller:

- High performance and very silence helicocentrifugal mixed flow, made in ABS plastic.
- **DUCT IN-LINE 100/130** with centrifugal impeller.

Accessories:

- Fixed plastic grills.

CODE	MODEL	EAN CODE	Speed (r.p.m)	Input Power (W)	Max. Amps (A)	AirFlow (m³/h)	Sound Pressure Level dB(A)	Weight (kg)
SERIE TIMER								
00771000	DUCT IN-LINE 100/130 T	8422248920742	2.200	25	0,16	130	24	1,2
00702100	DUCT IN-LINE 100/270 T	8422248021210	2.300/1.700	30/18	0,18/0,10	270/190	30/24	2,1
00703100	DUCT IN-LINE 125/320 T	8422248021234	2.300/1.700	30/18	0,18/0,10	365/250	32/26	2,1
SERIE ESTANDAR								
00770000	DUCT IN-LINE 100/130	8422248920735	2.200	25	0,16	130	24	1,2
00702000	DUCT IN-LINE 100/270	8422248021203	2.300/1.700	30/18	0,18/0,10	270/190	30/24	2,1
00703000	DUCT IN-LINE 125/320	8422248021227	2.300/1.700	30/18	0,18/0,10	365/250	32/26	2,1
00704000	DUCT IN-LINE 150/560	8422248021241	2.700/2.000	80/60	0,36/0,27	595/420	33/27	3,2
00705000	DUCT IN-LINE 160/560	8422248021265	2.700/2.000	80/60	0,36/0,27	595/420	33/27	3,2
00706000	DUCT IN-LINE 200/910	8422248021289	2.700/2.000/1.800	85/65/55	0,34/0,27/0,24	910/820/720	39/34/32	4,5

DIMENSIONS mm

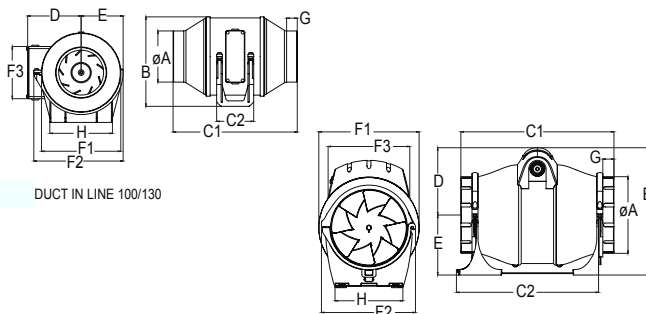

	Ø A	B	C1	C2	D	E	F1	F2	F3	G	H
DUCT IN LINE 100/130	98	171,5	238	71	102,5	80,5	152	171	100	20	120
DUCT IN LINE 100/270	98	232	315	241,6	117	115	168	180	155	25	130
DUCT IN LINE 125/320	122	232	279	241,6	117	115	168	180	155	25	130
DUCT IN LINE 150/560	147	244	293,4	272,4	129	115	192	180	158	21	130
DUCT IN LINE 160/560	157	244	312,6	272,4	129	115	192	180	158	23	130
DUCT IN LINE 200/910	197	278,5	353,6	272,4	138,5	140	211	230	161,5	51,5	142

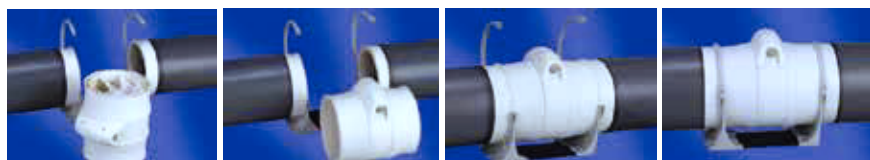

In line fans with soundproof box.

BOX IN LINE



IP-44

Box:

- Sheet steel box.
- Thermal and acoustic insulation.
- Inspection door for easy access to motor and maintenance.
- Outlets according current norms and with rubber gasket in order to avoid vibration and leak.
- Mounting feet for easy installation on ceiling or wall.
- Terminal box outside.

Housing:

- High efficient centrifugal fan (polypropylene) with aerodynamical design. (1)

Motor:

- External rotor, **IP-44** insulation class **B**.
- 230V 50Hz/60Hz.
- Speed controlled.
- Maximum working temperature +50°C.

Impeller:

- Forward curved impeller directly mounted on motor shaft.

Accessories:

- Electrical speed controllers **REGM**.

CODE	MODEL	EAN CODE	Speed (r.p.m)	Input Power (W)	Max. Amps (A)	Maximum AirFlow (m ³ /h)	Sound Pressure Level dB(A)	Weight (kg)
00722000	BOX IN-LINE 100	8422248018081	2.220	0,08	0,65	300	29	6
00723000	BOX IN-LINE 125	8422248018098	2.220	0,08	0,65	420	29	6
00724000	BOX IN-LINE 150	8422248018104	2.220	0,23	1,05	580	38	7
00725000	BOX IN-LINE 200	8422248018111	1.280	0,10	0,75	890	42	9

DIMENSIONS mm

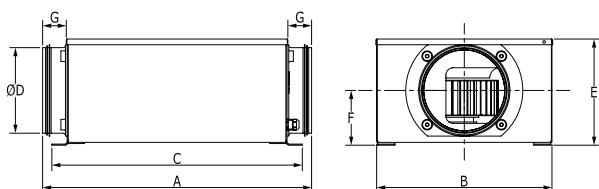

	A	B	C	Ø D	E	F	G
BOX IN-LINE 100	505	285	419	100	166	86	70
BOX IN-LINE 125	445	285	419	125	166	86	40
BOX IN-LINE 150	471	309	439	150	186	96	42
BOX IN-LINE 200	530	404	484	200	246	124	50

Duct fans for installation in rigid and flexible tubes.

MT



**EASY
INSTALLATION**

- Very silent fans.
- Plastic housing and impeller.
- All models and versions fitted with 220-240V 50/60Hz motors, **IP-X2** protection and class **B** as standard.
- Mounting support for 100 and 100 T is optional.
- White finishing.

CODE	MODEL	EAN CODE	VERSION	Ø (mm)	Speed (r.p.m)	Input Power (W)	Maximum AirFlow (m³/h)	Sound Pressure Level dB(A)	Weight (kg)	Units per box
TIMER SERIES										
00711000	MT-100 T	8422248920513	●	100	2500	15	98	41	0,4	10
STANDARD SERIES										
00710000	MT-100	8422248920186	●	100	2500	15	98	41	0,4	10
00720000	MT-125	8422248920520	●	125	2450	20	190	43	0,6	10
00730000	MT-150	8422248920797	●	150	2100	25	320	45	1,2	5

DIMENSIONS mm

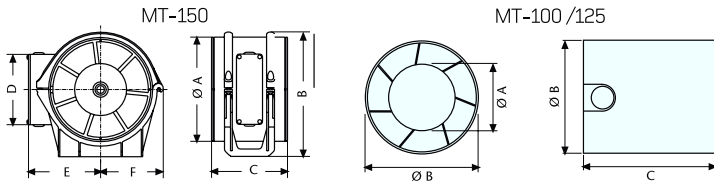

	Ø A	B	C	D	E	F
MT-100	60	97	92	-	-	-
MT-125	65	118	96	-	-	-
MT-150	148	177	108	100	99,5	89,2



Duct fans with installation kit to be installed in ductings with flexible and rigid tubes.

KIT IN LINE

- Composed by MT series, flexible PVC ducts and two fixed plastic grills.
- Plastic housing and impeller.

CODE	MODEL	EAN CODE	VERSION	Ø (mm)	Speed (r.p.m)	Input Power (W)	Maximum AirFlow (m³/h)	Sound Pressure Level dB(A)	Weight (kg)	Units per box
TIMER SERIES										
00711100	KIT IN LINE 100 T	8422248920216	●	100	2500	15	98	41	1,10	10
STANDARD SERIES										
00710100	KIT IN LINE 100	8422248920209	●	100	2500	15	98	41	1,10	10
00720100	KIT IN LINE 125	8422248920612	●	125	2450	20	190	43	1,83	10
00730100	KIT IN LINE 150	8422248920803	●	150	2100	25	320	45	2,10	5

DIMENSIONES

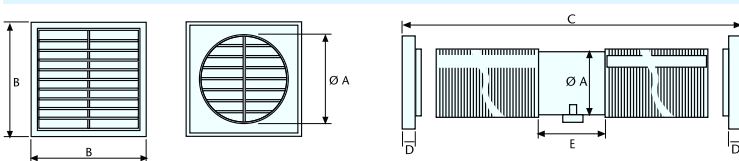

	Ø A	B	C	D	E
KIT IN LINE 100	100	140	3.000	15	92
KIT IN LINE 125	124	140	3.000	18	106
KIT IN LINE 150	150	175	3.000	15	108

Versions



STANDARD
In combination with light, fans switches on.



TIMER
Electronic timer adjustable from 3 to 15 minutes.

WALL FANS

Helicoidal fans to be installed in walls or windows.

LHV

- Modern design.
- Impeller with low **noise profile and high efficiency**.
- **Window kit included.**
- Protection guard on inlet side.
- Series with 230 V, 50 motor, protection **IP-44**, insulation class **B** (type 160 IP-X4).
- Speed controlled.
- Working temperature from: -20°C to +50°C.



Ø 400

Ø 350

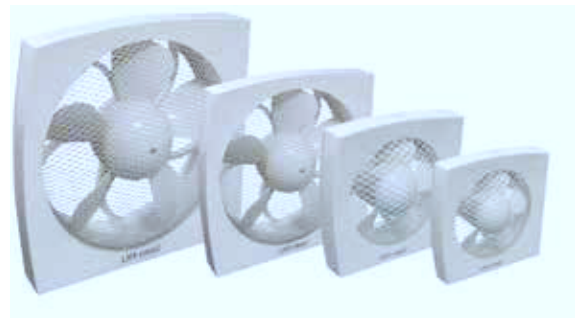

Ø 300

Ø 225

Ø 190

Ø 160

CODE	MODEL	EAN CODE	Ø (mm)	Speed (r.p.m)	Input Power (W)	Maximum AirFlow (m³/h)	Sound Pressure Level dB(A)	Weight (kg)	Units per box
00660000	LHV 160	8422248009324	160	1750	20	450	40	1,2	1
00661000	LHV 190	8422248009331	190	1500	30	700	42	1,7	1
00662000	LHV 225	8422248009348	225	1150	45	900	44	3	1
00663000	LHV 300	8422248009355	300	1050	50	1450	47	3,4	1
00664000	LHV 350	8422248009362	350	1300	100	1850	52	4,3	1
00665000	LHV 400	8422248009379	400	1400	215	3150	55	7,4	1

DIMENSIONS mm

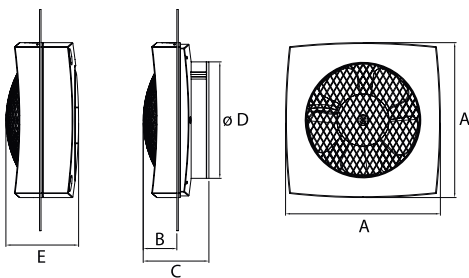

	A	B	C	Ø D	E
LHV 160	210	46	89	160	99
LHV 190	250	54	97	194	109
LHV 225	285	61	110	229	123
LHV 300	370	77	125	315	144
LHV 350	430	85	142	365	159
LHV 400	490	95	160	415	181

Helicoidal fans to be installed in walls or windows.

B-23 / B-30



AUTOMATIC SHUTTER SYSTEM

REVERSIBLE FAN

- Elegant design.
- **Glass installation kit included as standard.**
- Protection guard on inlet side.
- Fitted with 230V 50 Hz motors, **IP-X4** protection and class **B** as standard.
- Fully adjustable.
- Working temperatures from -20°C to +50°C.
- Model **B**: MATIC (with automatic blind).
- **RA**: Reversible with 5-speed adjuster.

CODE	MODEL	EAN CODE	Ø (mm)	Speed (r.p.m)	Input Power (W)	Max. Amps (A)	Maximum AirFlow (m³/h)		Sound Pressure Level dB(A)	Weight (kg)	Units per box
							extract	intake			
00610000	B-23	8422248120234	230	1350	45	0,19	825	530	49	5,19	1
00620000	B-30	8422248120241	305	1260	90	0,39	1900	700	51	7,45	1
00611003	B-23 RA	8422248007740	230	1350	45	0,19	825	530	49	5,19	1
00621003	B-30 RA	8422248007764	305	1260	90	0,39	1900	700	51	7,45	1

DIMENSIONS mm

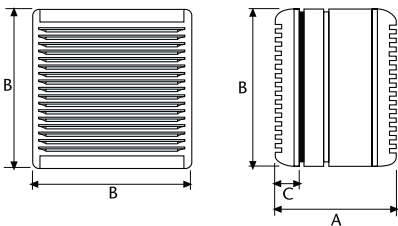

	A	B	C
B-23/RA	190	340	40
B-30/RA	230	420	40

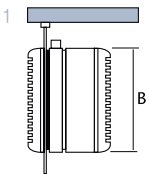

KITCHEN EXTRACTION

Centrifugal extract fan for kitchens.

PROFESSIONAL 750 / 750L / 500

EASY
INSTALLATION

EXCELLENT
PERFORMANCE

WASHABLE
FILTERS



PROFESSIONAL 750/750L



PROFESSIONAL 500

- High air flow capacity.
- High efficient centrifugal impeller.
- Metal grease filter.
- **Easy to install and clean.**
- 750 model with metal housing and plastic impeller.
- 500 model with plastic housing and impeller.
- Energy class: C (model PROFESSIONAL 750)
F (model PROFESSIONAL 750L)
D (model PROFESSIONAL 500)



Lámparas
2 x 40W
modelo
PROFESSIONAL 750L

CODE	MODEL	EAN CODE	Ø (mm)	Speed (r.p.m)	Input Power (W)	Maximum AirFlow (m³/h)	Sound Pressure Level dB(A)	Weight (kg)	Units per box
00117000	PROFESSIONAL 750	8422248100816	120	1.200	125	700	49	5	3
00117100	PROFESSIONAL 750 L	8422248100823	120	1.200	125	700	49	5	3
00117400	PROFESSIONAL 500	8422248010832	100	1.900	150	450	57	2,09	4

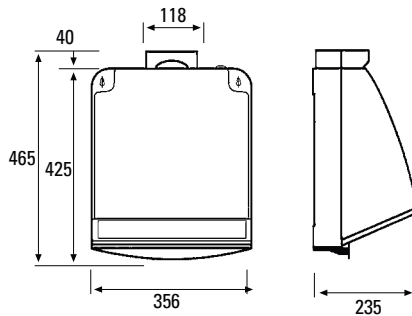

PROFESSIONAL 750/750L

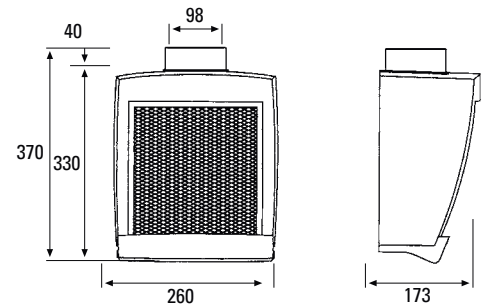

PROFESSIONAL 500

Dimensions in mm

Centrifugal extract fan for kitchens.

600 PLUS 2V / GS 600



- High air flow capacity.
- Metal housing and high performance plastic impeller.
- Plate to collect grease.
- Easy to install and clean.
- The 600 Plus model incorporates a 2 speeds switch that can be wall mounted.
- Metallic grease filter in GS 600 PLUS and protection guard in GS 600.
- Energy class: C



CODE	MODEL	EAN CODE	Ø (mm)	Speed (r.p.m)	Input Power (W)	Maximum AirFlow (m³/h)	Sound Pressure Level dB(A)	Weight (kg)	Units per box
00116110	600 PLUS 2 VEL.	8422248006316	120	1.185	105	420/600	52	4	4
00116002	GS 600	8422248100601	110	1.180	105	480	50	4,8	4

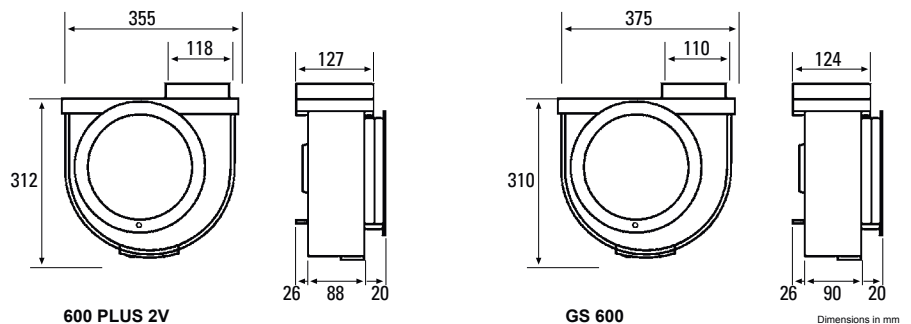

GS 400M / GS 400P



- GS 400 M with metal housing GS 400 P with thermal plastic housing.
- Standard protection guard in all types.
- Plate to collect grease.
- Easy to install.
- Energy class: B



CODE	MODEL	EAN CODE	Ø (mm)	Speed (r.p.m)	Input Power (W)	Maximum AirFlow (m³/h)	Sound Pressure Level dB(A)	Weight (kg)	Units per box
00114102	GS 400M	8422248100403	110	2.200	60	290	52	2,98	4
00111002	GS 400P	8422248100830	110	2.200	60	290	52	2,02	4

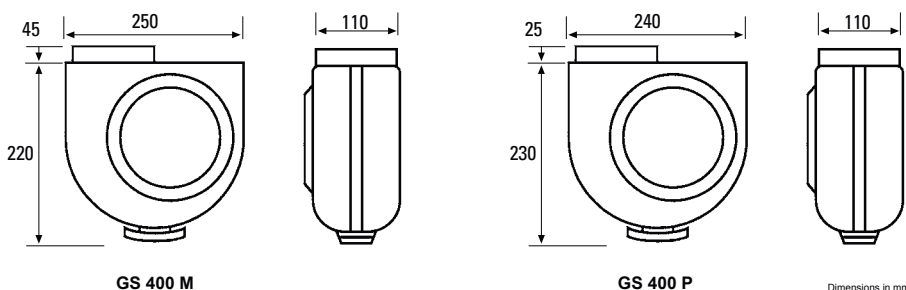



DOMESTIC VENTILATION RANGE ACCESSORIES

FIXED GRILL

GRILL
ON PRESSURE

GLASS KIT

RING FIXTURE

E-100	REF.	01910200	01910300		
E-120	REF.	01920200	01920300		
E-150	REF.	01930200	01930300		
X-MART 10	REF.	01910200	01910300	01970000	01910100
X-MART 12	REF.	01920200	01920300	01971000	01920100
X-MART 15	REF.	01930200	01930300	01972000	01930100
X-MART 10 MATIC	REF.	01910200	01910300	01970000	01910100
X-MART 12 MATIC	REF.	01920200	01920300	01971000	01920100
X-MART 15 MATIC	REF.	01930200	01930300	01972000	01930100
X-MART 10 INOX	REF.				
X-MART 12 INOX	REF.				
X-MART 15 INOX	REF.				
X-MART 10 MATIC INOX	REF.				
X-MART 12 MATIC INOX	REF.				
X-MART 15 MATIC INOX	REF.				
SILENTIS 10	REF.	01910200	01910300		
SILENTIS 12	REF.	01920200	01920300		
SILENTIS 15	REF.	01930200	01930300		
SILENTIS 10 INOX	REF.				
SILENTIS 12 INOX	REF.				
SILENTIS 15 INOX	REF.				
B-10 Plus /C (00281000)	REF.	01910200	01910300		
B-12 Plus /C (00282000)	REF.	01920200	01920300		
B-15 Plus /C (00283000)	REF.	01930200	01930300		
B-12 Plus Timer	REF.	01920200	01920300		01920100
B-15 Plus Timer	REF.	01930200	01930300	01983000	01930100
B-10	REF.	01910200	01910300	01910000	01910100
B-12	REF.	01920200	01920300	01920000	01920100
B-15	REF.	01930200	01930300	01930000	01930100
B-10 MATIC	REF.	01910200	01910300	01910000	01910100
B-12 MATIC	REF.	01920200	01920300	01920000	01920100
B-15 MATIC	REF.	01930200	01930300	01930000	01930100
B-10 PIR	REF.	01910200	01910300	01910000	01910100
CB-100	REF.	01910200	01910300		01910100
CB-100 Plus	REF.	01910200	01910300		
MT-100	REF.	01910200	01910300		
MT-125	REF.	01920200	01920300		
MT-150	REF.	01930200	01930300		
B-23	REF.				
B-30	REF.				
B-23 RA	REF.				
B-30 RA	REF.				
DUCT IN LINE 100/130	REF.	01910200	01910300		
DUCT IN LINE 100/270	REF.	01910200	01910300		
DUCT IN LINE 125/320	REF.	01920200	01920300		
DUCT IN LINE 150/560	REF.	01930200	01930300		
LHV-160	REF.		01560160		
LHV-190	REF.		01560190		
LHV-225	REF.		01560225		
LHV-300	REF.		01560300		
LHV-350	REF.		01560350		
LHV-400	REF.		01560400		
PROFESSIONAL 750	REF.				
PROFESSIONAL 500	REF.				
GS-600 Plus 2V	REF.				

TECHNICAL CHARACTERISTICS		KITCHEN EXTRACTION					
Models	PROFESSIONAL 750	PROFESSIONAL 750 L	PROFESSIONAL 500	600 PLUS 2V	GS 600	GS 400 M	GS 400 P
Code	00117000	00117100	00117400	00116110	00116002	00114102	00111002
Product features according to directives							
EU65/2014 - EN61591, EN60704-2-13, EN50564							
AEC (Annual Energy consumption) (kWh/annum)	54	173,4	73,5	54,8	51,7	29,2	30,3
EEL class (Energy Efficiency Class)	C	F	D	C	C	B	B
FDE (Fluid Dynamic Efficiency)	9,5	4,6	4,5	9,3	12,5	10,7	10,5
FDE class (Fluid Dynamic Efficiency Class)	E	F	F	E	E	E	E
LE (Lighting Efficiency) (lux/W)	-	1,1	-	-	-	-	-
LE class (Lighting Efficiency Class)	-	G	-	-	-	-	-
GFE (Grease Filtering Efficiency)	53,7	53,7	51,9	51,9	-	-	-
GFE Class (Grease Filtering Efficiency class)	F	F	F	F	-	-	-
Air flow at minimum speed (m3/h)	-	-	-	420	-	-	-
Air flow at maximum speed (m3/h)	600	600	450	600	480	290	290
Air flow at intensive speed (TURBO) (m3/h)	-	-	-	-	-	-	-
Sound Power Level at minimum speed (dB)	-	-	-	45	-	-	-
Sound Power Level at maximum speed (dB)	49	49	57	52	50	52	52
Sound Power Level at intensive speed (TURBO) (dB)	-	-	-	-	-	-	-
Po (Power Consumption in off mode) (W)	0	0	0	0	0	0	0
Ps (Power Consumption in standby) (W)	0	0	0	0	0	0	0
Integration directive EU 66/2014							
f (Time Increase Factor)	1,7	1,8	1,8	1,7	1,6	1,6	1,6
EEL (Energy Efficiency Index)	86	111,9	97,4	84,5	78,9	68,7	69,7
QBEP (Flow Rate at Best Efficiency Point) (m3/h)	287,3	287,3	128,8	285,9	311,7	163,2	174,2
PBEP (Static Pressure Difference at Best Efficiency Point) (Pa)	106	106	136,3	105	131,6	117	110,6
WBEP (Electric Power Input at Best Efficiency Point) (W)	89,1	169,1	109,5	90,1	91,4	49,6	51,1
WL (Nominal Power Consumption of Lighting system) (W)	-	80	-	-	-	-	-
EMIDDLE (Average Illumination of Lighting system on Cooking surface) (lux)	-	84	-	-	-	-	-
Features							
Motor	INDUCCION	INDUCCION	INDUCCION	INDUCCION	INDUCCION	INDUCCION	
Maximum Power Consumption	105W	105W	125W	105W	105W	60W	60W
Maximum Pressure	190	190	235	205	200	210	225
Intensive Speed (TURBO) Pressure	-	-	-	-	-	-	-
Control Type	-	-	-	CONMUTADOR	-	-	-
Automatic Switch Off	NO	NO	NO	NO	NO	NO	NO
Electronic Filter Saturation Indicator	NO	NO	NO	NO	NO	NO	NO
Filter Type	METALICO	METALICO	METALICO	METALICO	-	-	-
Anti-grease Filter Number	1	1	1	1	-	-	-
Inner Shield	NO	NO	NO	NO	NO	NO	NO
Extraction Capacity							
Extraction Levels	1	1	1	2	1	1	1
Lighting							
Light Type	-	Incandescente	-	-	-	-	-
Adjustable Intensity Lighting	-	NO	-	-	-	-	-
Nº of Lamps	-	2 X 40W	-	-	-	-	-
Electric Connection							
Total Rush Power (W)	105	185	125	105	105	60	60
Rated Voltage (V)	230	230	230	230	230	230	230
Network Frequency (Hz)	50	50	50	50	50	50	50
Electrical Insulation Class	CLASE I	CLASE I	CLASE II	CLASE I	CLASE I	CLASE I	CLASE I
Plug	-	-	-	-	-	-	-
External Dimensions							
Width (mm)	356	356	260	355	375	250	240
Depth (mm)	235	235	173	134	136	125	120
Installation							
Outlet Diameter (mm)	120	120	100	120	125	110	110
Minimum height distance to a electric worktop hob (mm)	65	65	65	65	65	65	65
Minimum height distance to a gas worktop hob (mm)	65	65	65	65	65	65	65
Installation with Outlet tube to the exterior / Recirculating	EXTERIOR	EXTERIOR	EXTERIOR	EXTERIOR	EXTERIOR	EXTERIOR	EXTERIOR
Easy Installation System	SI	SI	SI	SI	SI	SI	SI
Accessories							
Upper Decorative tube Extension	-	-	-	-	-	-	-
White Decorative Tube	-	-	-	-	-	-	-
Black Decorative Tube	-	-	-	-	-	-	-
Island Tube Enhancer	-	-	-	-	-	-	-
Check Valve	-	-	-	-	-	-	-
MAX PRO Metal Filter	-	-	-	-	-	-	-
Metal Filter	01140700	01140700	65200040	01100000	-	-	-
DUAL Filter (metal + active charcoal)	-	-	-	-	-	-	-
Active Charcoal Filter	-	-	-	-	-	-	-
Noiseless Flexible Duct	-	-	-	-	-	-	-
Kit Universal Led	-	-	-	-	-	-	-

PERFORMANCE CURVES

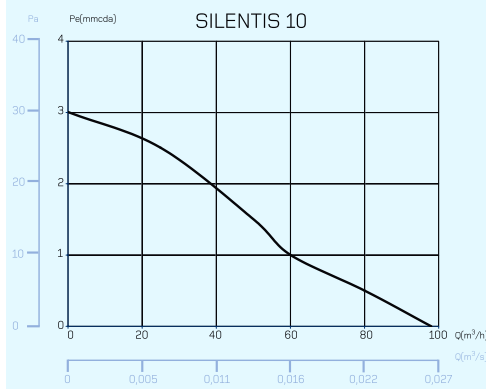
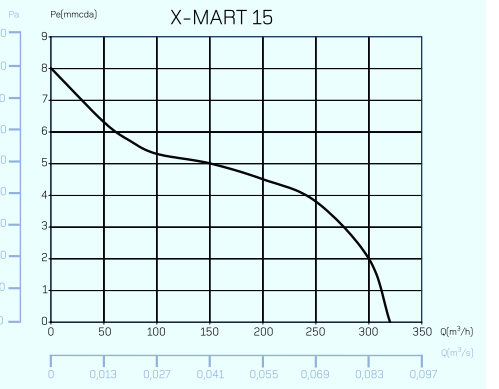
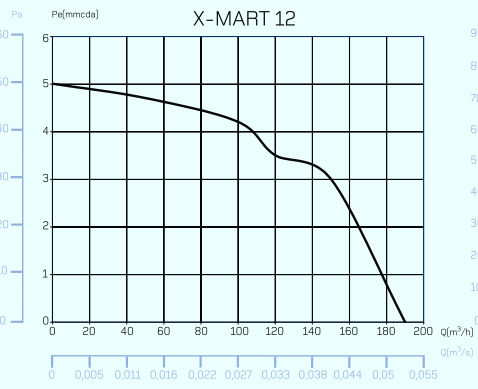
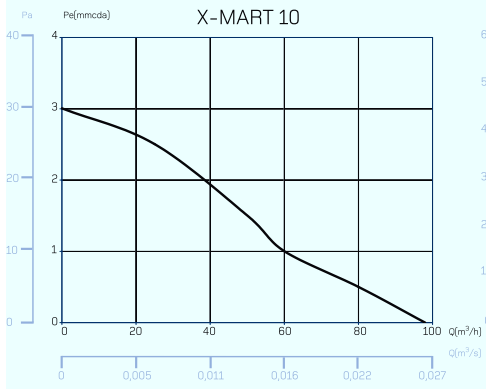
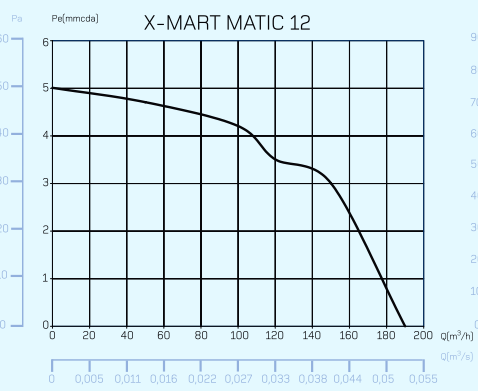
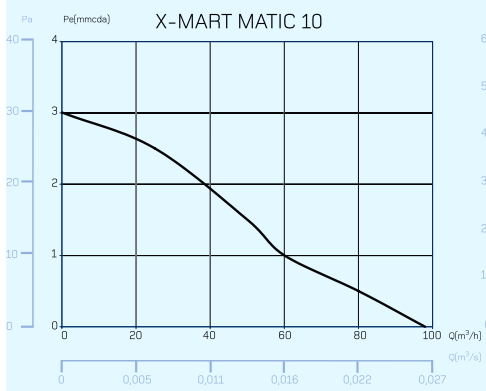
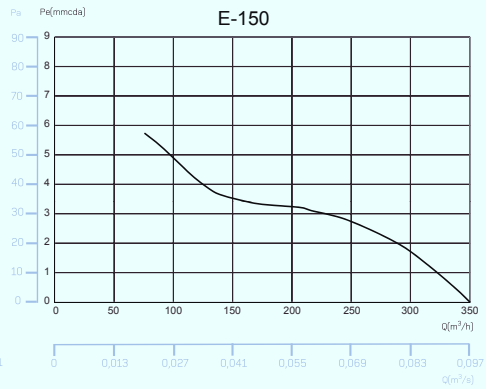
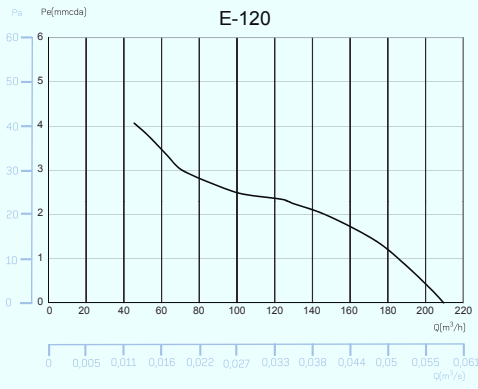
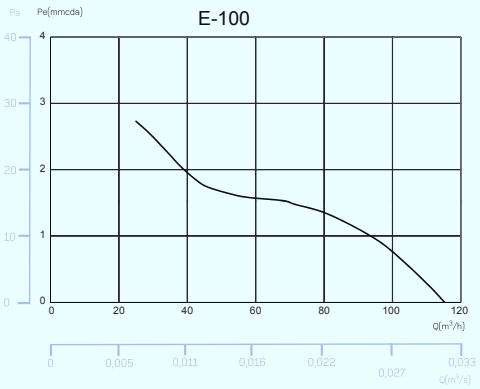

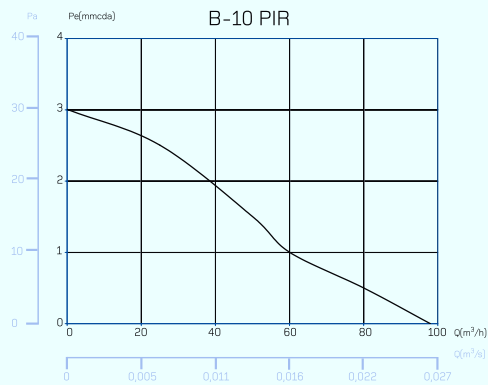
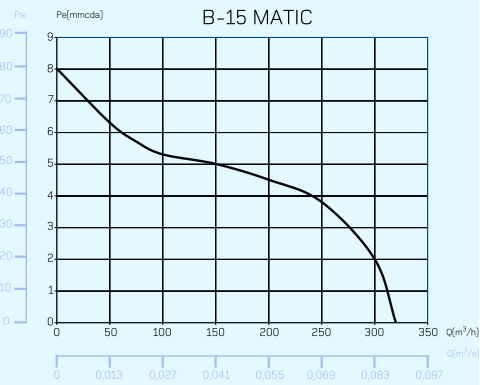
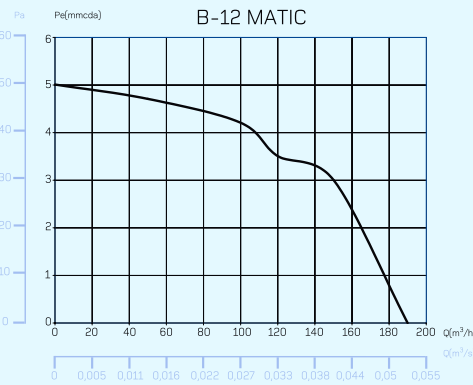
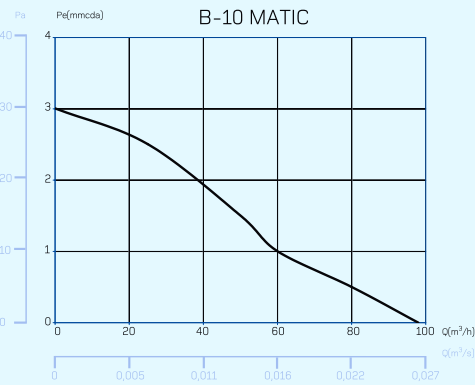
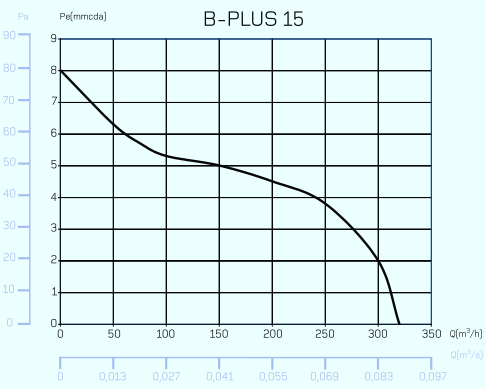
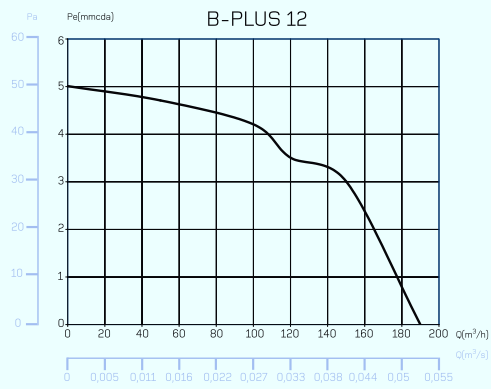
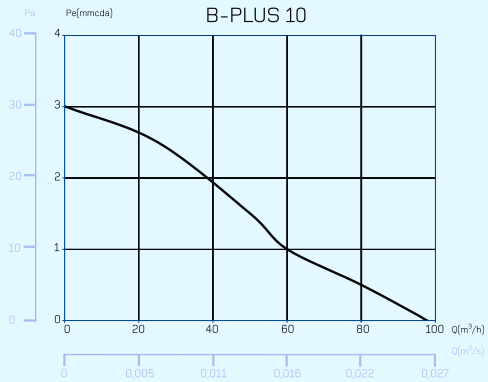
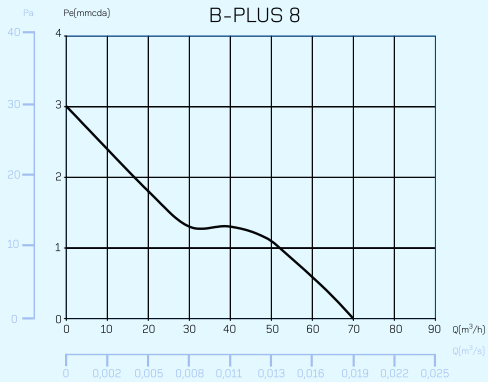

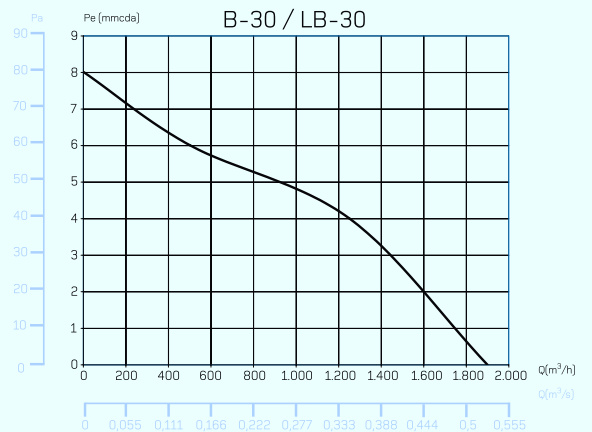
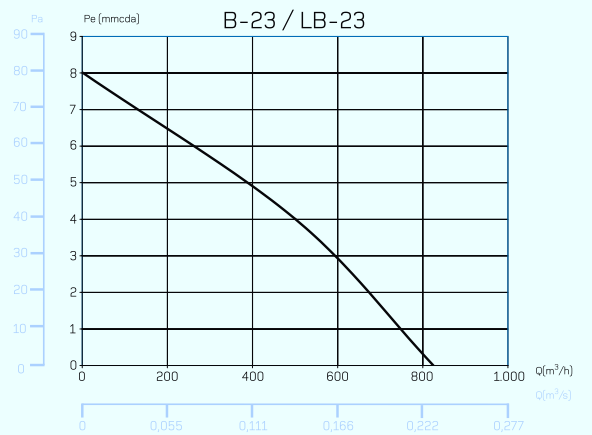
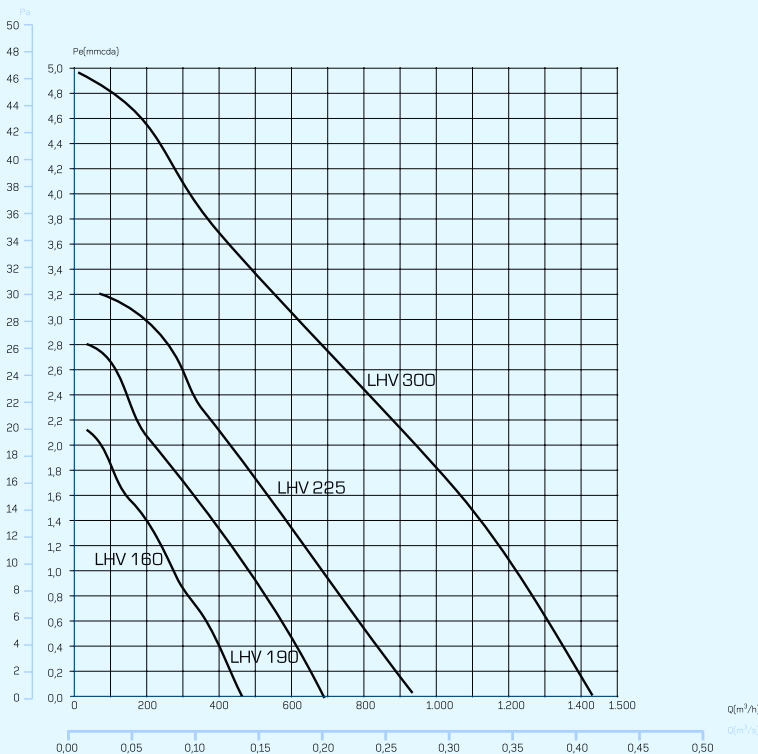
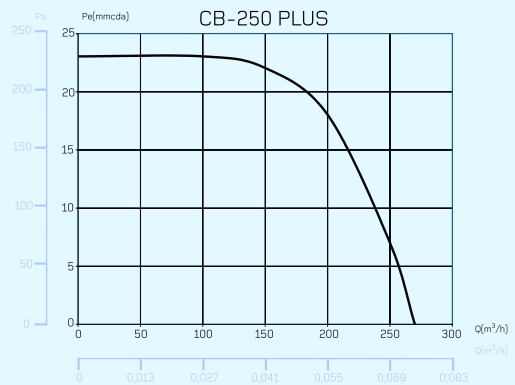
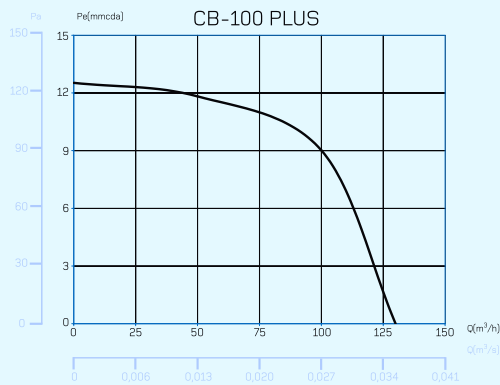
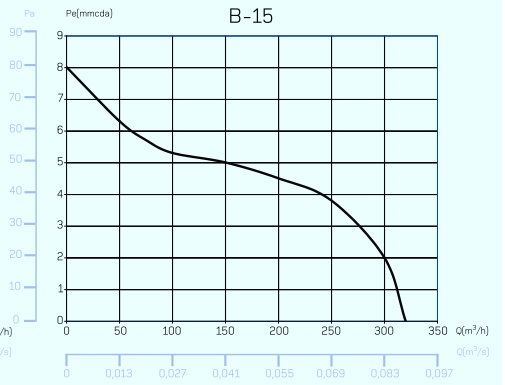
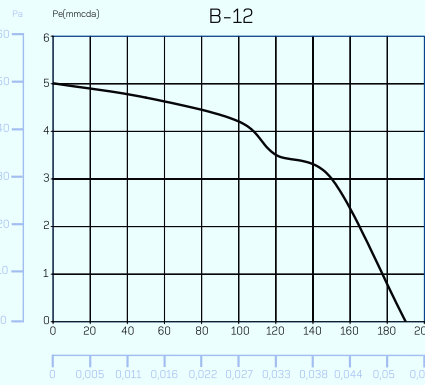
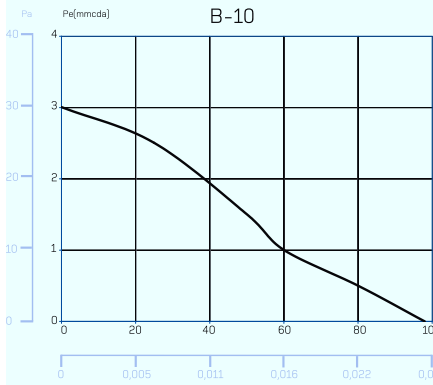

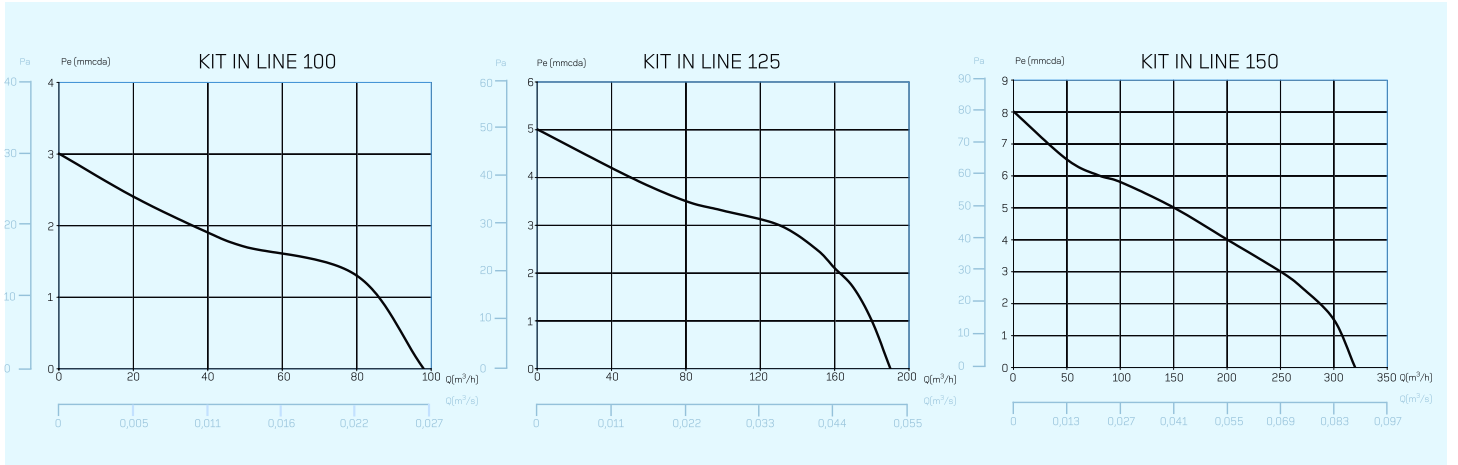
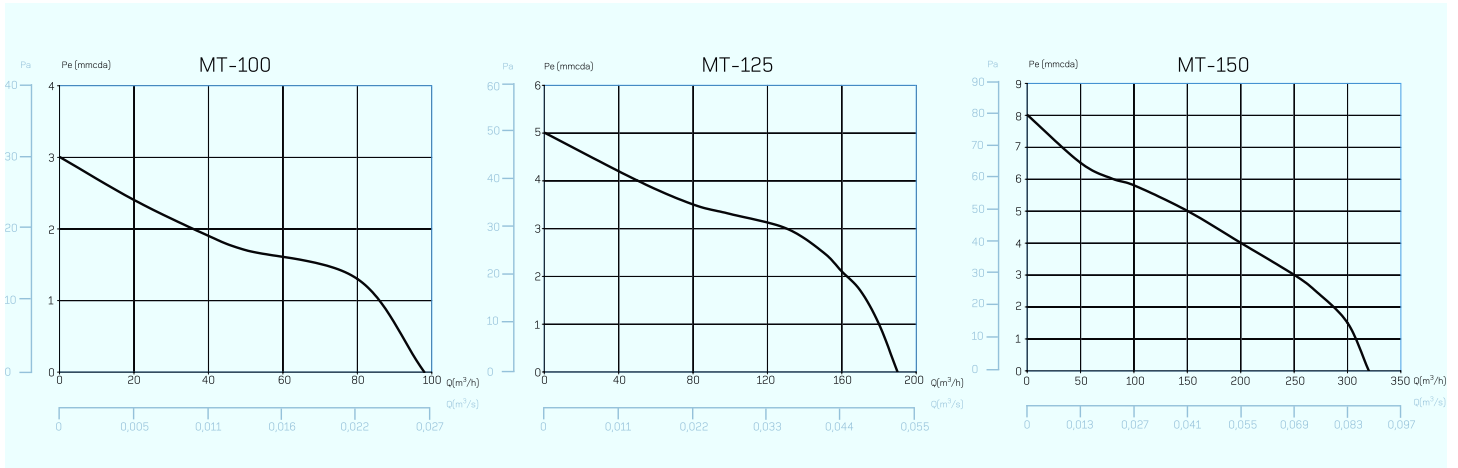
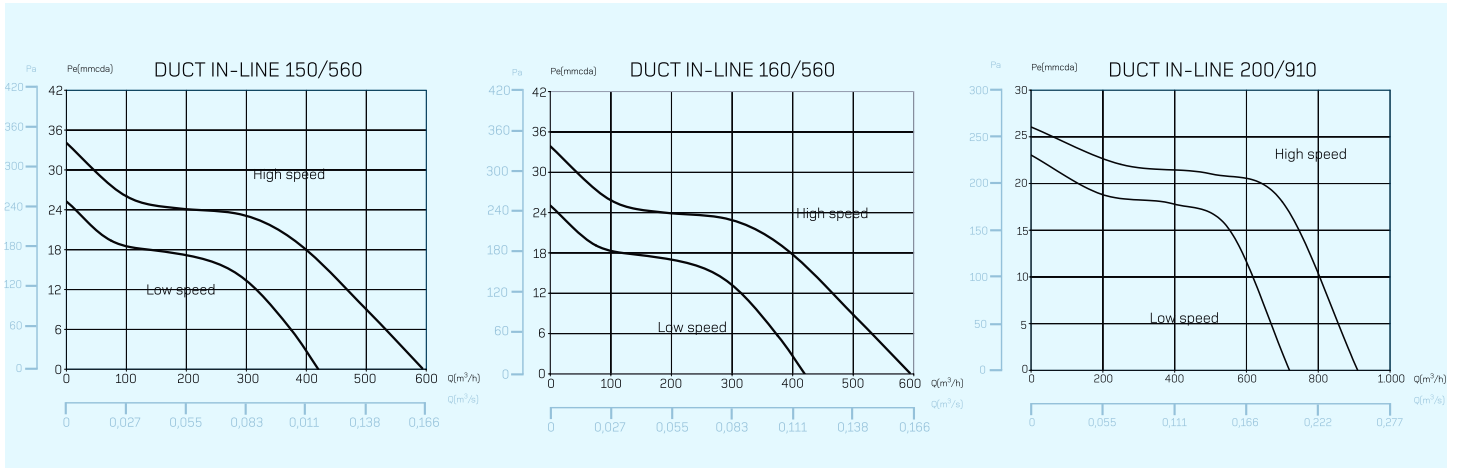
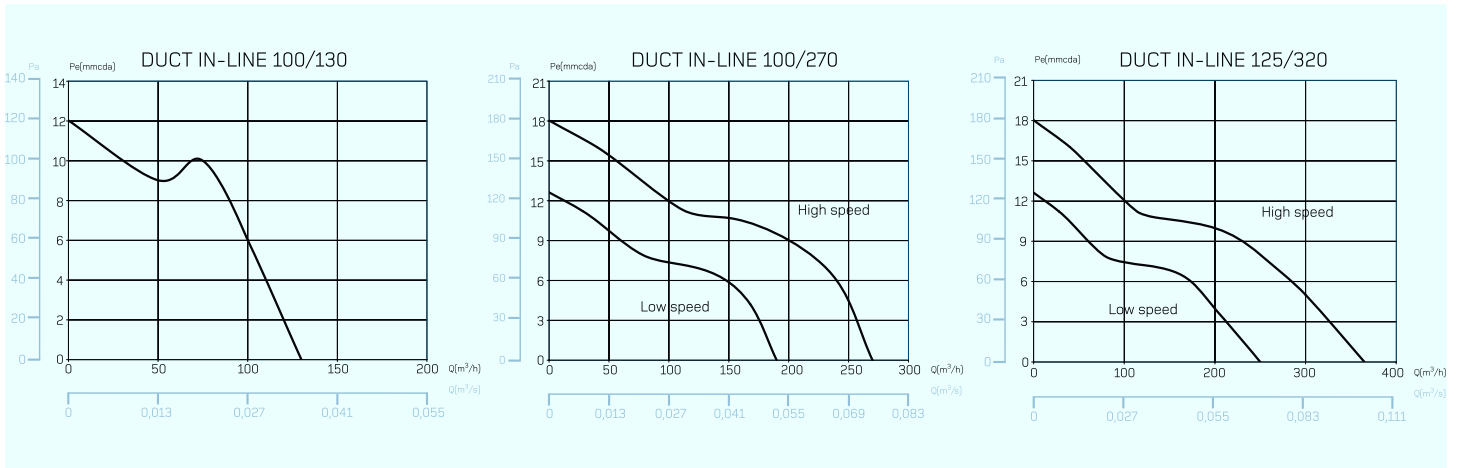

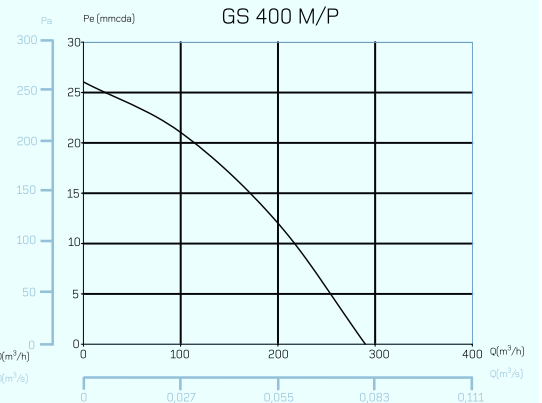
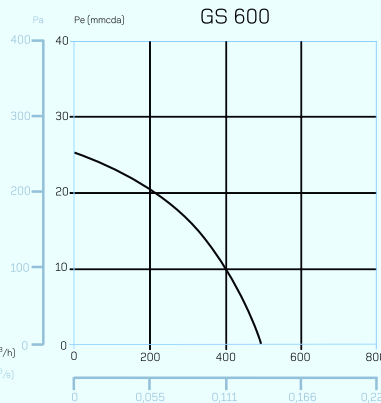
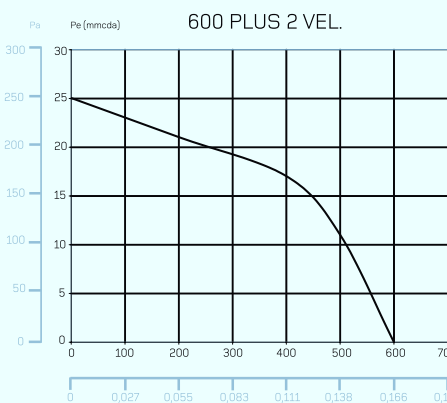
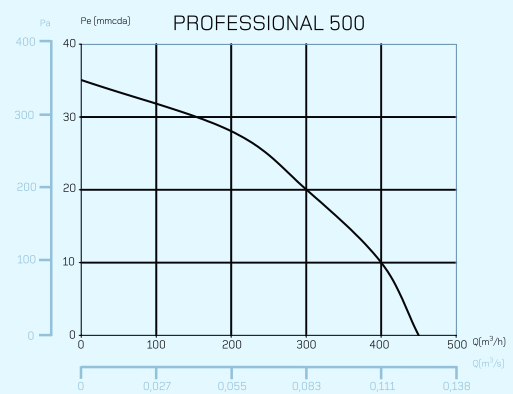
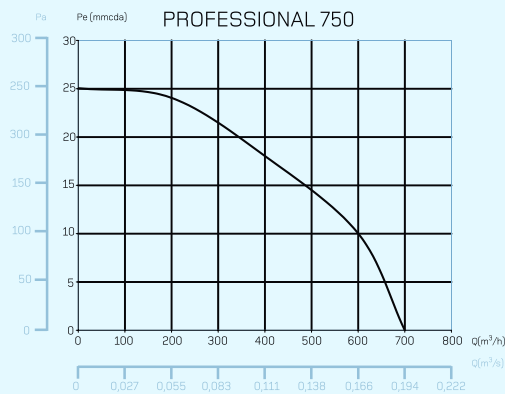
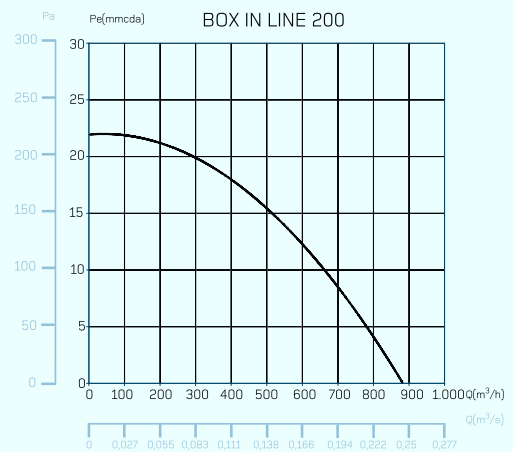
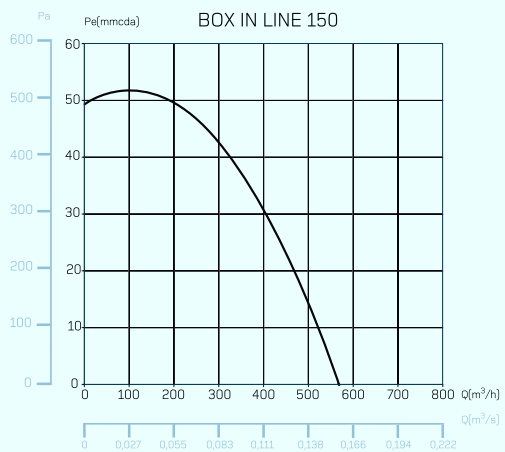
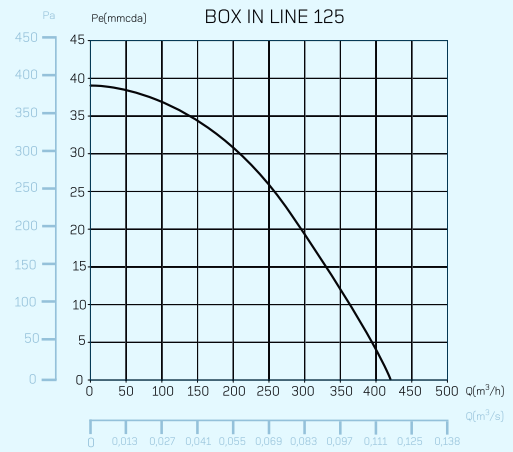
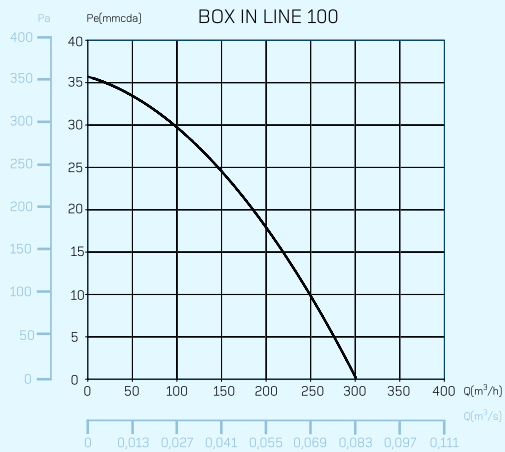

Concepts

BASIC VENTILATION CONCEPTS

WHAT IS VENTILATION?

Ventilation is understood to be the replacement of a portion of air which is considered undesirable (polluted), by another that provides an improvement both in terms of purity, and of temperature, humidity, etc.

FUNCTIONS

To maintain the air in an enclosure under suitable conditions of temperature, humidity, pressure, speed and degree of pollution to ensure the health and wellbeing of people, or living beings.

FLOW RATE

This is the amount of air displaced in a given unit of time. (The flow given in the technical specifications is at free discharge, in other words, with no pressure loss). Flow is shown as Q and is usually expressed in m³/h, although it is also commonly expressed in m³/min, m³/sec, l/s, C.F.M

$$1 \text{ m}^3/\text{h} = 3,6 \text{ l/s}$$

$$1,7 \text{ m}^3/\text{h} = 1 \text{ C.F.M}$$

The **FLOW RATE** and the section are related as follows:

$$Q = V * S = \text{m}^3/\text{h}$$

$$V = \text{Air speed (m/sec)}$$

$$S = \text{Section (m}^2\text{) of the duct}$$

$$S = \frac{d^2 * \Pi}{4}$$

WHAT IS PRESSURE?

It is the pushing force per surface unit that air needs to circulate and overcome the resistance of the system (pressure losses). Pressure is given in: mmH₂O and Pa

$$9,8 \text{ Pa} = 1 \text{ mmH}_2\text{O}$$

THERE ARE THREE TYPES OF PRESSURE:

Static Pressure (Pe): This is the force of the air in all directions on the walls of the tube, in a perpendicular direction to them.

Dynamic Pressure (Pd): Is the force that accelerates the air from zero to the velocity of the system. It is manifested only in the direction of the air.

There is a formula that links dynamic pressure and speed:

$$Pd = (V / 4,04)_2$$

Speed Table with its Dynamic Pressure (table 3)

Speed (m/s)	Dynamic Pressure mmH ₂ O
1	0.06
2	0.24
3	0.55
4	0.98
5	1.53
6	2.20
7	3.00
8	3.92
9	4.96
10	6.12
11	7.41
12	8.82
13	10.35
14	12.00
15	13.78
16	15.68
17	17.70
18	19.85
19	22.11
20	24.50
21	27.01
22	29.65

Total Pressure: This is the sum between the static pressure and the dynamic pressure $P_t = P_e + P_d$

WHAT IS NOISE?

It is the audible sound, that is propagated through the air and which is unpleasant to the receiver.

The **Sound Pressure (Lp)** level is what we really hear and it varies according to the premises and the distance between the source of the noise (extractor or fan) and the receiver.

The **Sound Power (Lw)** level is the amount of sound energy of a sound source (extractor or fan) every second and it is constant, in other words, it does not vary according to the premises or the distance from the sound source.

Concepts

BASIC VENTILATION CONCEPTS

Sound pressure level (dB)		
Noise	dB	Examples
DEAFENING	120	Thunder
	110	Cannon fire Steam whistle
VERY STRONG	100	Train in a tunnel
	90	Street with dense traffic
	80	Noisy factory
STRONG	70	Noisy office
	60	Medium-sized workshop
		Radio with the volume up high
MODERATE	60	Large shop Office
	50	
GENTLE	40	Public library
	30	Country road Scrunching up paper
		Quiet conversation
VERY GENTLE	20	Peaceful church
	10	Silent night
	0	Hearing limit

HOW TO CHOOSE A FAN

You need to know the following parameters:

- Output
- Pressure
- Sound level
- Type of Electricity Supply

Output (Q m³/h): You have to determine the necessary flow according to:

- 1 • The recommended renewals with regard to the volume of the premises in m³ and the activity there.

$$Q = m^3 \cdot \text{Renow/h}$$

RENEW./HOUR TABLE

Result of Health and Safety studies/Experience

INDUSTRIAL PREMISES

Noxious atmospheres	30-60
Goods deposit	3-6
Cast-iron	20-30
Industrial laundry	15-30
Machine room	20-30
Workshop (general)	8-10
Workshop with kilns	30-60
Tooling workshop	5-10
Paint workshop	30-60
Welding workshop	15-30
Dry cleaner	20-30

SERVICES SECTOR AND PREMISES

	NR/h
Classroom	2-4
Bank	3-4
Bar-café	10-12
Library	3-5
Cinema-theatre	10-15
Industrial kitchen	15-30
Canteen	5-10
Recording studio	10-12
Garage	6-8
Gym	6-12
Entrance hall	3-5
Hospitals	4-6
Public lavatories	8-15
Laundry	15-30
Offices	4-8
Baker's	20-30
Restaurant	5-10
Dance hall	6-8
Conference room	8-12
Hairdressing salon	10-15
Meeting room	4-8

- 2 • The recommended renewals with regard to the number of people that there are in the premises.

$$Q = n^{\circ} \text{ person} \cdot m^3/h$$

Normal activity with no smoking	29 m ³ /h per person
Normal activity with smoking	58 m ³ /h per person
Light physical activity	45 m ³ /h per person
Industrial warehouses and premises	60 m ³ /h per person

Concepts

BASIC VENTILATION CONCEPTS

3• When localised extraction is required in the place where the contaminating source is, the flow (**Q**) will be determined taking the following into account:

- Surface area of the hood
- Speed of catchment
- Speed of transport by the recommended renewals system with regard to the number of people that there are in the premises.

$$Q = 3.600 \cdot V \cdot S = \text{m}^3/\text{h}$$

Q = Necessary air flow (**m³/h**)

V = Speed of catchment (**m/h**)

S = Hood or ducting section (**m²**)

LOCALISED EXTRACTION GUIDE COOKER HOODS			
Hood Class	Speed Catchment in m/sec On hood surface	Calculation per m ² of surface area of the hood	Speed of transport m/sec
4 sides open	from 1 to 1,2 m/sec.	3.500 to 4.500 m ³ /h	from 6 to 10 m/sec.
3 sides open	from 0,85 to 1 m/sec.	3.000 to 3.500 m ³ /h	
2 sides open	from 0,75 to 0,85 m/sec.	2.700 to 3.000 m ³ /h	
1 side open	from 0,5 to 0,75 m/sec.	1.750 to 2.700 m ³ /h	

THERMOS

Reliability & efficiency
Installation versatility
High quality components
Security

Reliability & Efficiency

By using double resistances circuit, Cata's new thermos offer greater reliability and guarantee proper operation. They incorporate the sheathed thermostat, extending the life of the component. In addition, their best polyurethane insulation foam free of CFC and HCFC of uniform density and perfect adhesion, guarantee minimum heat loss, a much smoother operation, allowing it to be one of the most efficient thermos in the market.

Installation versatility

All the models that appear in the catalog (except for TS-30 SL) offer two installation possibilities: vertical and horizontal installation. Thanks to the position of resistors, heaters can be installed horizontally or vertically, depending on the requirements of each user.

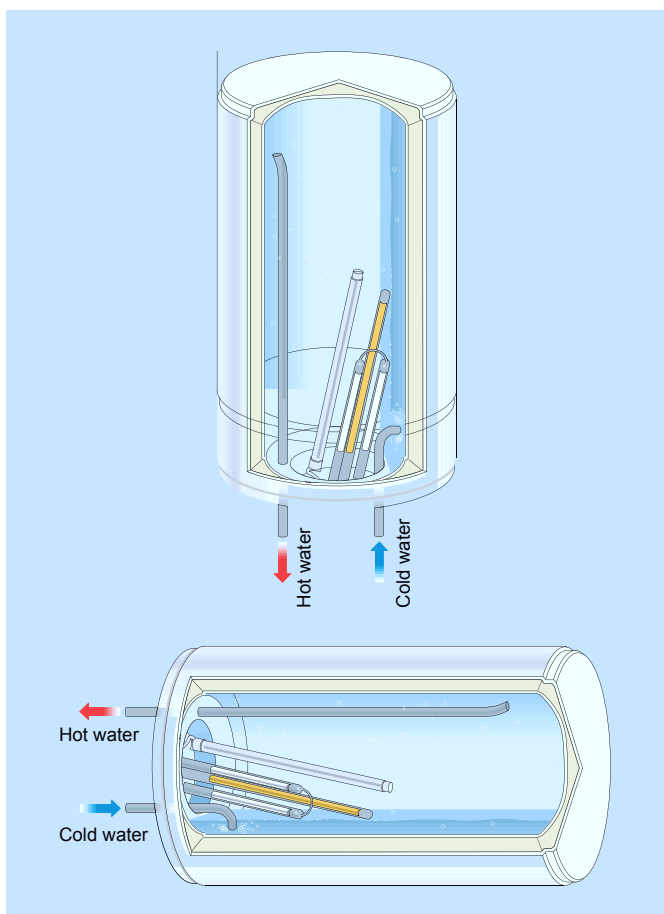

High quality components

The range of Cata thermos incorporate an outer rolled steel covering with epoxy paint protection, which prevents oxidation and gives it an IP24 protection rating. Inside it has high efficiency insulation, ensuring minimum heat loss. All models incorporate magnesium anode, guaranteeing perfect electrochemical protection. They also have sheathed resistors with double protective enamel and independent functioning, which can be replaced without draining the heat and allowing the heat to continue operating even if one of the resistors is not working.

Security

We offer products with electrical safety: through two thermostats, one for temperature control and another for security, which switches off the thermos in case of failure of the first one; and hydraulic safety, which prevents that the pressure inside the unit exceeds the nominal design pressure.



European standard for eco-design (Dir. 2009/125/EC) and energy labeling (Dir. 2010/30/EC)

Why this new legislation?

To help with climate change and to reduce energy consumption and natural resources of the European Community and its member countries. These rules have been developed for eco-design of products (ErP Directive) and regulations for energy labeling (Energy Labelling Directive) thereof in an effort to achieve an improvement of products and the natural resources used in its production and the energy resources used in its operation.

When?

Both the ErP Directive and Energy Labelling Directive will only be used for products launched on the market beginning on 09.26.2015. Products purchased before or already in the point of sale or stores distributors may continue be sold and installed though not meeting the new requirements.

Who is affected by these regulations?

We, the manufacturers, that must follow the established policy and begin to develop our products according to the ErP Directive, so as to improve its operating performance, in order to remove less efficient technologies from the market and, so that to be visible for the customer the products have to be labeled according to the Energy Labelling Directive, which also defines the responsibilities of suppliers and sellers.

The installation engineers. They should know which products follow the new directives of Eco-Design and inform customers about the reasons of the usage of more efficient appliances. In case of installing mixed heating systems the energy labeling for complete systems must also be elaborated (including boiler, solar support, accumulator, etc.)

And what about electric heaters?

According to the specific regulations for appliances that produce hot water (Reg. 814/2013), it is necessary to meet efficiency minimum requirements for appliances that can be produced and labeled with EC labeling. They also have to have an energy label and a data sheet as explained in Reg. 811/2013. The initial date to include this information in appliances is September 26, 2015.

Cata guarantees:

- All our electric thermos obey the directive.
- Detailed technical and normative information for our customers.
- Customer service available for any questions.

How do I read the energy label on my Cata thermos?

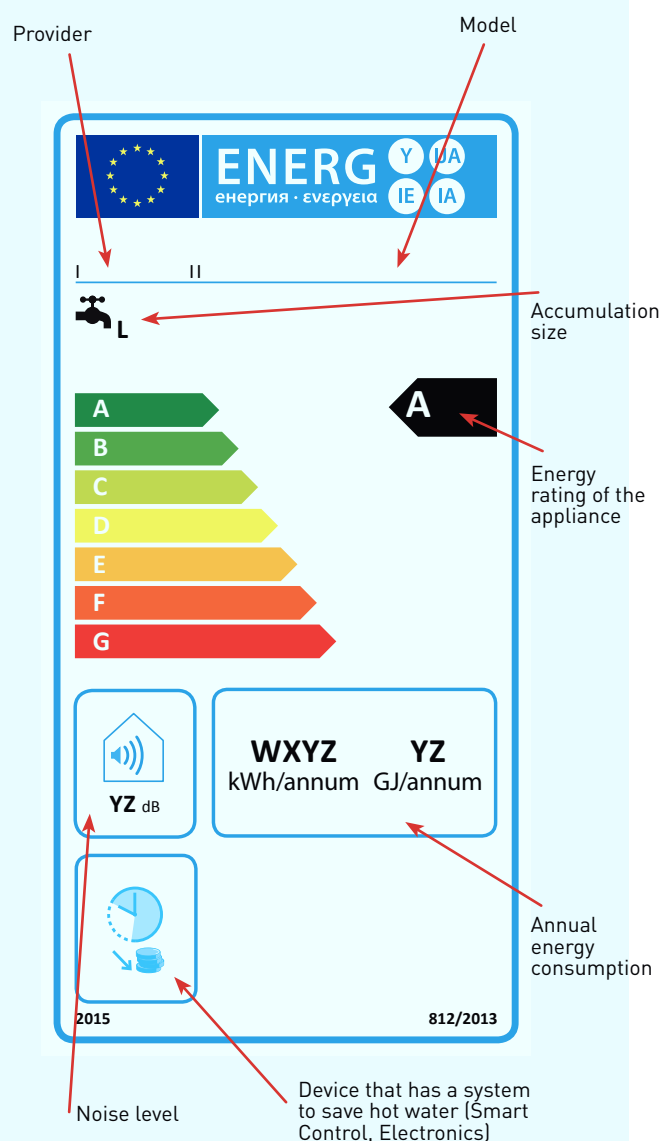

TS-30 SL

Thermos



- Round outer shape
- Vertical installation
- **Integrated in a cupboard**
- **Independent sheathed resistors 2 x 800 watts**
- **Steel cask with vitrified titanium enamel at 850°C**
- **Adjustable thermostat with front control**
- Heating indicator
- Magnesium anode
- **High efficiency insulation 25mm**
- Sheathed thermostatic sensor
- Safety thermostat
- Insulating sleeves
- 10bar safety valve with drain device
- Epoxy paint coated exterior
- 30L capacity

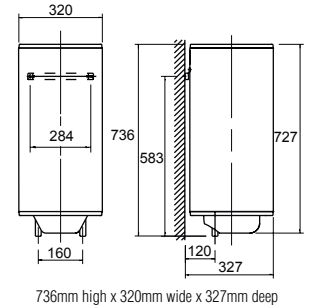

TS-30 SL

Code **03100000**

EAN **8422248065351**

TS-30 / TS-50

Thermos



- Round outer shape
- **Reversible: horizontal and vertical installation**
- **Independent sheathed resistors 2 x 800 watts**
- **Steel cask with vitrified titanium enamel at 850°C.**
- **Adjustable thermostat with front control**
- Heating indicator
- Magnesium anode
- **High efficiency insulation 25mm – 28mm**
- Sheathed thermostatic sensor
- Safety thermostat
- Insulating sleeves
- 10bar safety valve with drain device
- Epoxy paint coated exterior
- 30L – 50L capacity

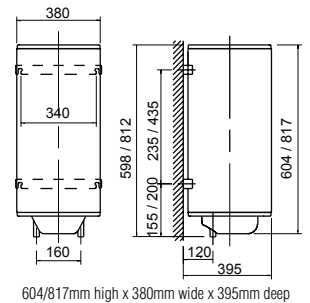

TS-30

Código **03110000**

EAN **8422248065368**

TS-50

Código **03111000**

EAN **8422248065375**

TS-75 / TS-100

Thermos



- Round outer shape
- **Reversible: horizontal and vertical installation**
- **Independent sheathed resistors 2 x 900 watts**
- **Steel cask with vitrified titanium enamel at 850°C**
- **Adjustable thermostat with front control**
- Heating indicator
- Magnesium anode
- **High efficiency insulation 33mm**
- Sheathed thermostatic sensor
- Safety thermostat
- Insulating sleeves
- 10bar safety valve with drain device
- Epoxy paint coated exterior
- 75L – 100L capacity

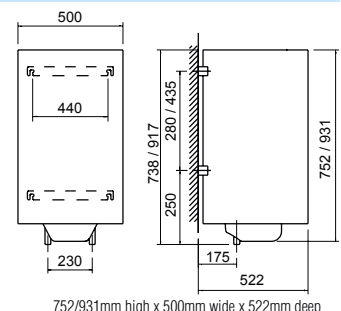

TS-75

Código **03112000**

EAN **8422248065382**

TS-100

Código **03113000**

EAN **8422248065399**

TECHNICAL SPECIFICATIONS	THERMOS				
Models	TS-30 SL	TS-30	TS-50	TS-75	TS-100
Code	03100000	03110000	03111000	03112000	03113000
EAN Code	8422248065351	8422248065368	8422248065375	8422248065382	8422248065399
Capacity (l)	30	30	50	75	100
Installation	vertical	vertical / horizontal	vertical / horizontal	vertical / horizontal	vertical / horizontal
Thermostat control position	front	front	front	front	front
Temperature regulation (°C)	20-70	20-70	20-70	20-70	20-70
Heating indicator panel	•	•	•	•	•
Magnesium anode	•	•	•	•	•
Power supply (V/Hz)	230/50	230/50	230/50	230/50	230/50
Type of resistor	Independent sheathed	Independent sheathed	Independent sheathed	Independent sheathed	Independent sheathed
Number of resistors and power (W)	2x800	2x800	2x800	2x900	2x900
Power (W)	1.600	1.600	1.600	1.800	1.800
Intensity to 230 V (A)	7	7	7	7,82	7,82
Heating time to 65°C (+50°C)	1h 05min	1h 05min	1h 50min	2h 25min	3h 15min
Static losses to 65°C (kWh in 24h)*	0,63	0,64	0,77	0,93	1,09
Average thickness of insulation (mm)	25	25	28	33	33
Water connection (BSP)	1/2"	1/2"	1/2"	3/4"	3/4"
Highest pressure (bar)	10	10	10	10	10
Electrical connection (cable with plug)	•	•	•	•	•
Water fall vertical Protection	•	•	•	•	•
Water projection protection	•	•	•	•	•
Protection rate	IP24	IP24	IP24	IP24	IP24
Net weight (kg)	14,5	14,5	19,5	28	33,5
Accessories					
Round cinch	-	-	-	02831001	02831001
EAN Code	-	-	-	8422248065566	8422248065566





Exclusive importer and distributor:

ELMAT SLOVAKIA s.r.o.

1. Maja 99/24

901 01 Malacky

Slovak Republic

cata@elmat.sk

website: www.elmat.sk

M: +421 903 430 803 - Mr Gabriel Puskac

B2B, B2G, B2C electro eshop: www.digestor.info

Your digital electro storage

Dostupnosť konkrétnych výrobkov si prosíme overte na eshope, emailom, alebo telefonicky.
Please check current availability of particular products at our eshop, by email or by phone.



Miesta predaja nájdete na:

The Points of Sales you can find at:

B2B, B2G, B2C digital electro storage www.digestor.info